

VERSTELBAAR

OLIVIA

Adjustable
∞



IP40

OLIVIA
Met schakelaar
Schroefbevestiging



OLIVIA NS
Zonder schakelaar
Schroefbevestiging



Installatie | Muur
Materialen | Aluminium | Afwerking | Chroom

JACOB

Adjustable
∞



IP40

JACOB
Met schakelaar
Schroefbevestiging



JACOB NS
Zonder schakelaar
Schroefbevestiging



Installatie | Muur
Materialen | Aluminium | Afwerking | Chroom

ROBIN

Adjustable
∞



IP40

ROBIN
Met schakelaar
Schroefbevestiging



Installatie | Muur
Materialen | Samengesteld materiaal | Afwerking | Wit of metaalkleurig grijs

NICOLE

Adjustable
∞



IP40

NICOLE
Met schakelaar
Schroefbevestiging



Installatie | Muur
Materialen | Aluminium | Afwerking | Chroom

Afmetingen - mm (inch)

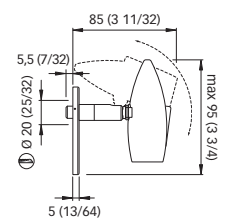
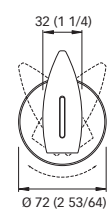
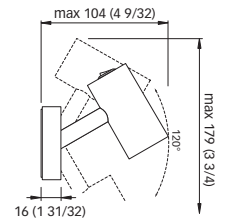
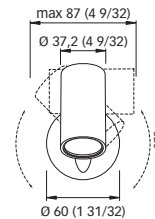
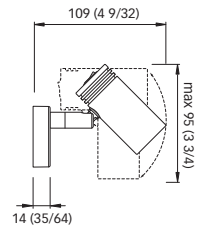
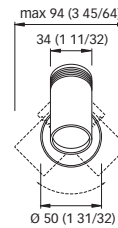
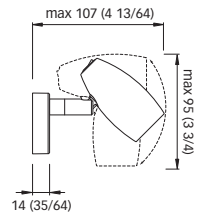
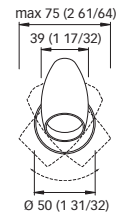

IP40 III CE

Model	OLIVIA / JACOB / ROBIN	NICOLE
Lichtbron	LED	LED
Stroomvoorziening	10 - 30 Vdc	10 - 30 Vdc
Stroomverbruik	2,5 W	1,2 W
Absorptie	0,21 A @ 12 V / 0,11 A @ 24 V	0,1 A @ 12 V / 0,05 A @ 24 V
LED-bescherming	Beschermd tegen spanningspieken ± 500 V Tegen omkering van polariteit	Beschermd tegen spanningspieken ± 500 V Tegen omkering van polariteit
Polariteit gevoelig	Ja	Ja

Kleurtemperatuur	Daglicht	Warm wit	Koel-Wit	Daglicht	Warm wit
	3800-4100 K°	2900-3100 K°	5600-6000 K°	3800-4100 K°	2900-3100 K°
CRI (kleurweergave-index)	≥ 80	≥ 80	-	-	-
Lichtstroom	160 lm	140 lm	75 lm	70 lm	65 lm

LED LEESLAMPEN

VERSTELBAAR

JOYCE

Adjustable
∞

IP40



JOYCE
Met schakelaar
Schroefbevestiging



JOYCE NS
Zonder schakelaar
Schroefbevestiging

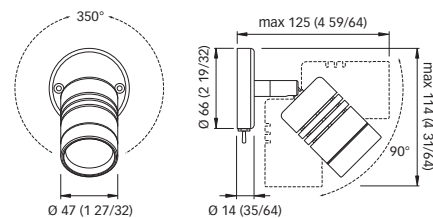

Afmetingen- mm (inch)

Installatie | Muur
Materialen | Aluminium
Afwerking | Chroom

MAYA 30

Flexible
~

IP40



MAYA 30
Met schakelaar
Schroefbevestiging



Installatie | Universeel
Materialen | Aluminium
Afwerking | Chroom

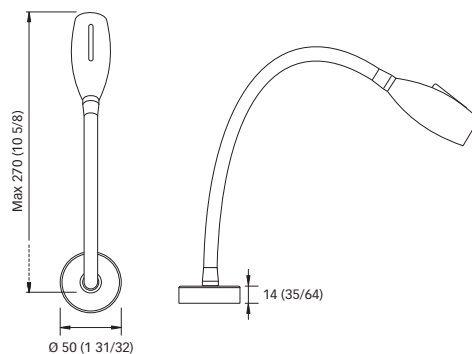

MAYA 60

Flexible
~

IP40



MAYA 60
Met schakelaar
Schroefbevestiging



Installatie | Universeel
Materialen | Aluminium
Afwerking | Chroom



MAYA 30 / MAYA 60

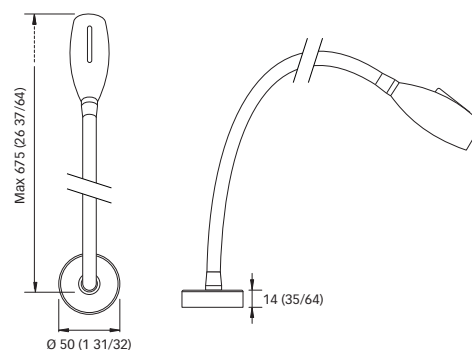

Afmetingen- mm (inch)

IP40

Model	JOYCE	MAYA 30/60		
Lichtbron	LED	LED		
Stroomvoorziening	10 - 30 Vdc	10 - 30 Vdc		
Stroomverbruik	3 W	1,2 W		
Absorptie	0,25 A @ 12 V / 0,13 A @ 24 V	0,1 A @ 12 V / 0,05 A @ 24 V		
LED-bescherming	Beschermd tegen spanningspieken ± 500 V Tegen omkering van polariteit	Beschermd tegen spanningspieken ± 500 V Tegen omkering van polariteit		
Polariteit gevoelig	Ja	Ja		
Kleurtemperaturen	Daglicht 3800-4100 K°	Koel-wit 5600-6000 K°	Daglicht 3800-4100 K°	Warm wit 2900-3100 K°
CRI (kleurweergave-index)	≥ 80	-	-	-
Lichtstroom	110 lm	75 lm	70 lm	65 lm

LED LEESLAMPEN

AUDREY SERIES

AUDREY / NS



Flex



AUDREY NS
Zonder schakelaar

De voet-afwerking van de leer beklede modellen is gepolijst of geborsteld.

AUDREY

Met schakelaar
Schroefbevestiging



AUDREY NS

Zonder schakelaar
Schroefbevestiging



Installatie

Naar keuze

Materialen

Aluminium met gepolijst of gesatineerd chroom

Arm

Beschikbaar met en zonder bedekking

Flexibele arm bekleding

Zwart leer

Zwart neopreen

Bruin leer (Tabak, Chocolate of Donkerbruin gekleurd)

Wit leder

Andere afwerkingen beschikbaar op aanvraag.



AUDREY

Met schakelaar op kop

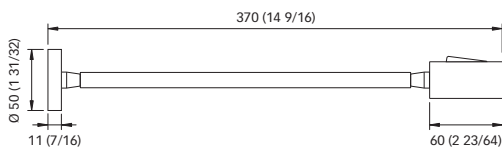

Basis

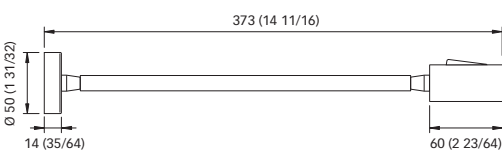

Basis imbutito

Afmetingen- mm (inch)

Model	AUDREY
Lichtbron	LED
Stroomvoorziening	10 - 30 Vdc
Stroomverbruik	1,5 W
Absorptie	0,12 A @ 12 V / 0,06 A @ 24 V
LED-bescherming	Beschermd tegen spanningspieken ± 500 V Tegen omkering van polariteit
Polariteit gevoelig	Ja
Kleurtemperatuur	Daglicht
	3800-4100 K°
CRI (kleurweergave-index)	≥ 80
Lichtstroom	75 lm

LED LEESLAMPEN

AUDREY WALL SERIES

AUDREY WALL / S2 / NS

Flexible



IP40

AUDREY WALL / AUDREY WALL S2

Met schakelaar
Schroefbevestiging



AUDREY WALL NS

Zonder schakelaar
Schroefbevestiging



Installatie

Muur

Materialen

Aluminium met gepolijst of gesatineerd chroom

Arm

Beschikbaar met of zonder bedekking

Flexibele arm bekleding

Zwart leer
Zwart neopreen
Bruin leer (Tabak, Chocolate of Donkerbruin gekleurd)
Wit leder

Andere afwerkingen beschikbaar op aanvraag.



AUDREY WALL
Schakelaar op kop



AUDREY WALL S2
Schakelaar onder de basis

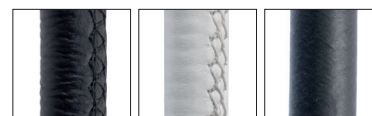

AUDREY WALL PL / S2

Flexible



IP40

AUDREY WALL PL S2

Met schakelaar
Schroefbevestiging



AUDREY WALL PL NS

Zonder schakelaar
Schroefbevestiging



Installatie

Muur

Materialen

Samengesteld materiaal

Kleuren

Chroom
Wit
Metaalkleurig donker grijs.

Arm

Beschikbaar met of zonder bedekking (*alleen chroom)

Armbekleding

Zwart neopreen



AUDREY WALL PL S2
Met schakelaar op kop

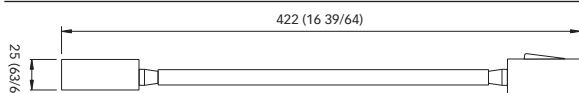

Afmetingen- mm (inch)

Model	AUDREY WALL		AUDREY WALL PL	
Lichtbron	LED		LED	
Stroomvoorziening	10 - 30 Vdc		10 - 30 Vdc	
Stroomverbruik	1,5 W		1,2 W	
Absorptie	0,12 A @ 12 V / 0,06 A @ 24 V		0,1 A @ 12 V / 0,05 A @ 24 V	
LED-bescherming	Beschermd tegen spanningspieken ± 500 V Tegen omkering van polariteit		Beschermd tegen spanningspieken ± 500 V Tegen omkering van polariteit	
Polariteit gevoelig	Ja		Ja	
Kleurtemperaturen	Daglicht		Koel-Wit	Daglicht
	3800-4100 K°		5600-6000 K°	3800-4100 K°
CRI (kleurweergave-index)	≥ 80		-	-
Lichtstroom	75 lm		75 lm	65 lm

LED LEESLAMPEN

CALIFFA SERIES

CALIFFA



Flexible

IP40



CALIFFA

Druk op schakelaar
Dit activeert de twee verschillende kleuren lampen.

Meerkleurig
Daglicht/ Rood

Schroefbevestiging

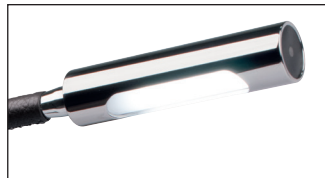

Installatie
Naar keuze

Materialen
Roestvrij staal AISI 316

Arm
Beschikbaar met en zonder bekleding

Armbekleding
Zwart leer
Bruin leerr(Tabak, Chocolate of Donkerbruin gekleurd)
Wit leder

Andere afwerkingen beschikbaar op aanvraag.

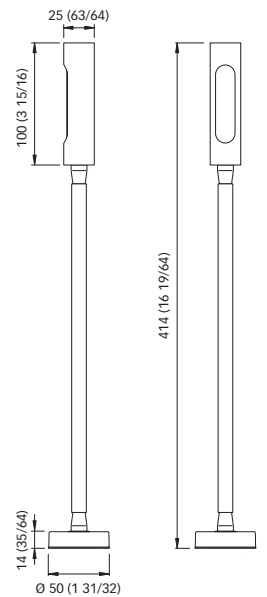

Afmetingen- mm (inch)



Model	CALIFFA
Lichtbron	LED
Stroomvoorziening	10 - 30 Vdc
Stroomverbruik	1,5 W
Absorptie	0,12 A @ 12 V / 0,06 A @ 24 V
LED-bescherming	Beschermd tegen spanningspieken ± 500 V Tegen omkering van polariteit
Polariteit gevoelig	Ja
Kleurtemperatuur	Daglicht
	3800-4100 K*
CRI (kleurweergave-index)	≥ 80
Lichtstroom	110 lm

LED LEESLAMPEN

CALIFFA WALL SERIES

CALIFFA WALL

Flexible

IP40



CALIFFA WALL

Druk op schakelaar

Dit activeert de twee verschillende kleuren lampen.

Meerkleurig

Neutraal wit / rood
Daglicht/ rood

Schroefbevestiging

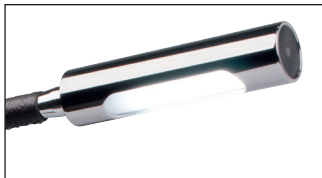

Installatie

Muur (Califfa Wall)

Materialen

Roestvrij staal AISI 316

Arm

Beschikbaar met en zonder bekleding

Armbekleding

Zwart leer

Bruin leerr(Tabak, Chocolate of Donkerbruin gekleurd)

Wit leder

Andere afwerkingen beschikbaar op aanvraag.

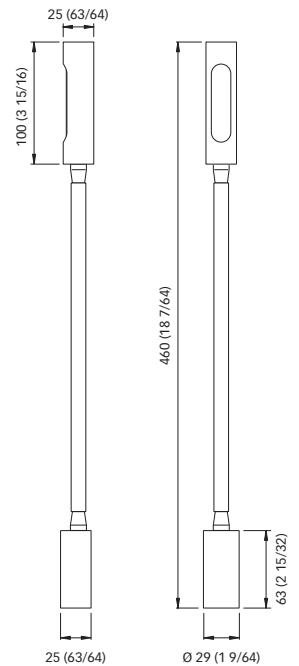

Afmetingen- mm (inch)



Model	CALIFFA WALL
Lichtbron	LED
Stroomvoorziening	10 - 30 Vdc
Stroomverbruik	1,5 W
Absorptie	0,12 A @ 12 V / 0,06 A @ 24 V
LED-bescherming	Beschermd tegen spanningspieken ± 500 V Tegen omkering van polariteit
Polariteit gevoelig	Ja
Kleurtemperatuur	Daglicht 3800-4100 K°
CRI (kleurweergave-index)	≥ 80
Lichtstroom	110 lm

LED LEESLAMPEN

SHARK SERIES

SHARK 30



Flexible

IP40



SHARK 30
Met schakelaar

Meerkleurig
Koel Wit / Rood

Schroef Installatie

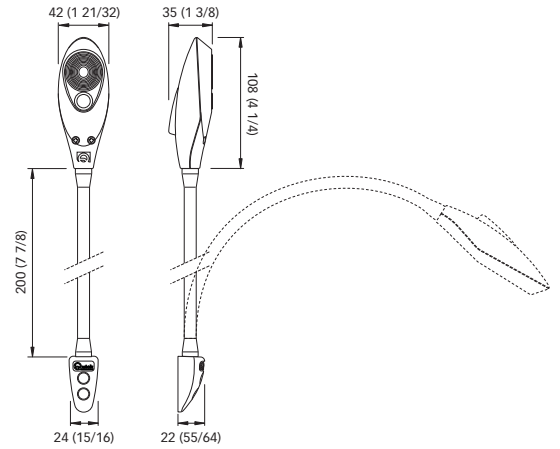

Afmetingen- mm (inch)

SHARK 50



Flexible

IP40



SHARK 50
Met schakelaar

Meerkleurig
Koel Wit/ Rood

Schroef Installatie

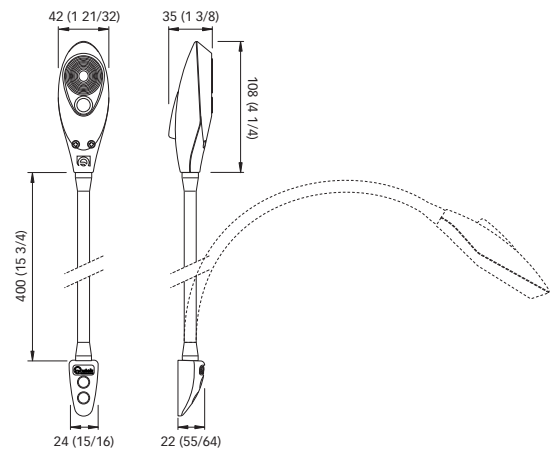

Afmetingen- mm (inch)

Installatie
Muur

Materialen
Samengesteld materiaal
Afwerking
Zwart

Meerkleurig
Koel Wit/ Rood

Model	SHARK 30/50
Lichtbron	LED
Stroomvoorziening	10 - 30 Vdc
Stroomverbruik	1,5 W
Absorptie	0,12 A @ 12 V / 0,06 A @ 24 V
LED-bescherming	Beschermd tegen spanningspieken ± 500 V Tegen omkering van polariteit
Polariteit gevoelig	Ja
Kleurtemperatuur	Koel- Wit 5600-6000 K°
CRI (kleurweergave-index)	≥ 80

LED LEESLAMPEN

BOOKLIGHT



BOOKLIGHT

Adjustable
∞



IP40

BOOKLIGHT
Lamp licht op bij openen.

Schroefbevestiging



Andere lampkleuren op
verzoek leverbaar.

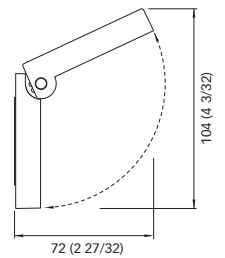
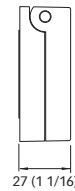
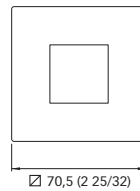

Afmetingen- mm (inch)



Installatie
Muur

Materialen
Samengesteld materiaal

Afwerking
Wit

Andere afwerkingen beschikbaar op aanvraag.

Model	BOOKlicht (12V)	BOOKlicht (24V)
Lichtbron	LED	LED
Stroomvoorziening	10 - 15 Vdc	20 - 30 Vdc
Stroomverbruik	1,5 W	1,5 W
Absorptie	0,125 A @ 12 V	0,063 A @ 24 V
LED-bescherming	Beschermd tegen spanningspieken ± 500 V Tegen omkering van polariteit	
Polariteit gevoelig	Ja	
Kleurtemperatuur	Warm wit 2900-3100 K°	
CRI (kleurweergave-index)	≥ 80	
Lichtstroom	70 lm	