

LED SPOTS

MINI SPOT

ELY



ELY - IP65
Veerbevestiging
 Ø Kroonlijst 39,5 mm
 Nis 34,5 mm
 Ø Uitsparing 30 mm

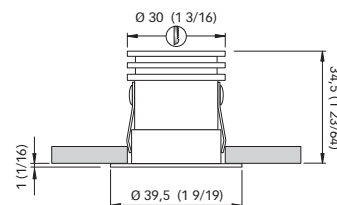

Afmetingen- mm (inch)

Installatie Plafond

Dimmable

Materialen
 Roestvrij staal AISI 316

Afwerking
 Gepolijst
 Satijn
 Andere afwerkingen beschikbaar op aanvraag.

Lichtbron

Stroomvoorziening

Stroomverbruik

Absorptie

LED-bescherming

Polariteit gevoelig

LED

10 - 30 Vdc

3 W

0,25 A @ 12 V / 0,125 A @ 24 V

Beschermd tegen spanningspieken ± 500 V

Ja

Kleurtemperatuur	Daglicht			Warm wit		
	3800-4100 K°			2900-3100 K° (2600-2800 K°*)		
CRI (kleurweergave-index)	≥ 80			≥ 80		
Lichtstroom	84 lm			75 lm		
Afstand	1 m	2 m	3 m	1 m	2 m	3 m
Diameter	0,74 m	1,47 m	2,21 m	0,74 m	1,47 m	2,21 m
Verlichtingssterkte	115,0 lux	28,8 lux	12,8 lux	102,72 lux	25,68 lux	11,41 lux
Straal	40°			40°		

*Op aanvraag beschikbaar

JO



JO - IP65
Schroefbevestiging
 Ø Kroonlijst 42 mm
 Nis 19 mm
 Ø Uitsparing 25 mm

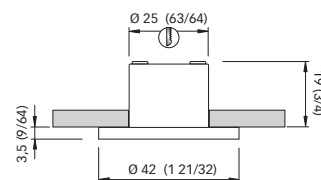

JD



JD - IP65
Schroefbevestiging
 Schuine kant 36X36 mm
 Nis 19 mm
 Ø Uitsparing 25 mm

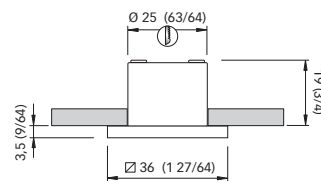

Afmetingen- mm (inch)

Installatie
 Plafond
Dimbaar

Materialen
 Roestvrij staal AISI 316

Afwerking
 Gepolijst
 Satijn
 Wit Ral 9010
 Andere afwerkingen beschikbaar op aanvraag.

Lichtbron

Stroomvoorziening

Stroomverbruik

Absorptie

LED-bescherming

Polariteit gevoelig

LED

10 - 30 Vdc

1,5 W

0,12 A @ 12 V / 0,06 A @ 24 V

Beschermd tegen spanningspieken ± 500 V

No

Kleurtemperatuur	Daglicht			Warm wit		
	3800-4100 K°			2900-3100 K° (2600-2800 K°*)		
CRI (kleurweergave-index)	≥ 80			≥ 80		
Lichtstroom	62 lm			57 lm		
Afstand	1 m	2 m	3 m	1 m	2 m	3 m
Diameter	0,20 m	0,41 m	0,61 m	0,20 m	0,41 m	0,61 m
Verlichtingssterkte	692,4 lux	173,1 lux	76,9 lux	637,0 lux	159,3 lux	70,8 lux
Straal	15°			15°		

*Op aanvraag beschikbaar

LED SPOTS

ERICA SERIES

InstallatiePlafond
Dimbaar

Materialen
Roestvrij staal AISI 316

Afwerking
Gepolijst
Satijn
Ral 9010

Andere afwerkingen beschikbaar op aanvraag.

IP65  

ERICA 1



ERICA 1 - 2W - IP65

Veerbevestiging
Schuine kant 50X50 mm
Nis 35 mm
Ø Uitsparing 40 mm

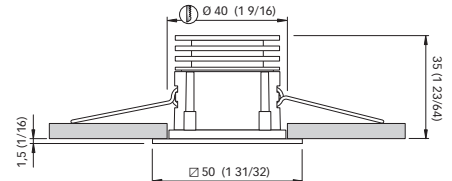

Afmetingen- mm (inch)

Modellen	ERICA 1					
Lichtbron	LED					
Stroomvoorziening	10 - 30 Vdc					
Stroomverbruik	2 W					
Absorptie	0,17 A @ 12 V / 0,08 A @ 24 V					
LED-bescherming	Beschermd tegen spanningspieken ± 500 V					
Polariteit gevoelig	Ja					
Kleurtemperatuur	Daglicht			Warm wit		
	3800-4100 K°			2900-3100 K° (2600-2800 K°*)		
CRI (kleurweergave-index)	≥ 80			≥ 80		
Lichtstroom	80 lm			70 lm		
Afstand	1 m	2 m	3 m	1 m	2 m	3 m
Diameter	0,70 m	1,40 m	2,10 m	0,70 m	1,40 m	2,10 m
Verlichtingssterkte	118,2 lux	29,6 lux	13,1 lux	103,7 lux	25,9 lux	11,5 lux
Straal	40°			40°		

*Op aanvraag beschikbaar

ERICA 2



ERICA 2 - 4W - IP65

Veerbevestiging
Schuine kant 50X100 mm
Nis 35 mm
Ø Uitsparing 40 mm

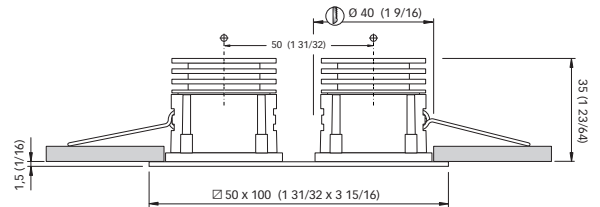

Afmetingen- mm (inch)

ERICA 3



ERICA 3 - 6W - IP65

Veerbevestiging
Schuine kant 50X150 mm
Nis 35 mm
Ø Uitsparing 40 mm

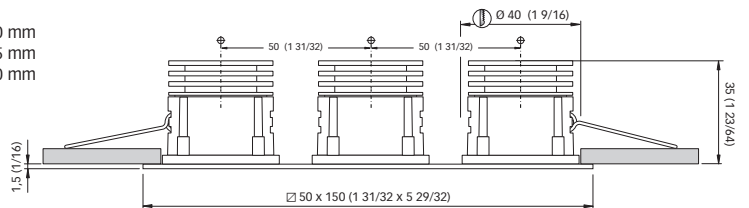

Modellen	ERICA 2						ERICA 3					
Lichtbron	LED						LED					
Stroomvoorziening	10 - 30 Vdc						10 - 30 Vdc					
Stroomverbruik	4 W						6 W					
Absorptie	0,33 A @ 12 V / 0,17 A @ 24 V						0,50 A @ 12 V / 0,25 A @ 24 V					
LED-bescherming	Beschermd tegen spanningspieken ± 500 V						Beschermd tegen spanningspieken ± 500 V					
Polariteit gevoelig	Ja						Ja					
Kleurtemperatuur	Daglicht			Warm wit			Daglicht			Warm wit		
	3800-4100 K°			2900-3100 K° (2600-2800 K°*)			3800-4100 K°			2900-3100 K° (2600-2800 K°*)		
CRI (kleurweergave-index)	≥ 80			≥ 80			≥ 80			≥ 80		
Lichtstroom	161 lm			141 lm			241 lm			211 lm		
Afstand	1 m	2 m	3 m	1 m	2 m	3 m	1 m	2 m	3 m	1 m	2 m	3 m
Diameter	0,70 m	1,40 m	2,10 m	0,70 m	1,40 m	2,10 m	0,70 m	1,40 m	2,10 m	0,70 m	1,40 m	2,10 m
Verlichtingssterkte	236,4 lux	59,1 lux	26,3 lux	207,37 lux	51,84 lux	23,04 lux	354,6 lux	88,7 lux	39,4 lux	311,1 lux	77,8 lux	34,6 lux
Straal	40°			40°			40°			40°		

*Op aanvraag beschikbaar

LED SPOTS

CLUB SERIES



AISI 316 L STAINLESS STEEL

Gepolijst
Satijn
RAL9010

CLUB (C)

Model 2WIP40/IP66
Dimbaar

Lichte kleur
Daglicht
Warm wit
Blauw
Rood

MEERKLEURIG



2W wit licht + gekleurd Sfeerverlichting

Daglicht-blauw
Warm wit-blauw
Daglicht-rood
Warm wit-rood

CLUB SWITCH (CS)

Model 2W met schakelaar
IP40
Niet dimbaar

Lichte kleur
Daglicht
Warm wit
Rood

CLUB TOUCH (CT)

Model 2W met aanraakschakelaar
IP40/IP66
Dimbaar

Aan / uit en dimmer
Druk op schakelaar

Lichte kleur
Daglicht
Warm wit
Rood

CLUB (C) DUAL

Tweekleurig model 2W + 2W
IP40/IP66
Dimbaar



Dubbel licht

2W wit licht + 2W gekleurd licht

Daglicht-blauw
Warm wit-blauw
Daglicht-rood
Warm wit-rood

CLUB SERIES Led inbouwspots

TED C IP40	MIRIAM C IP40	EDWIN C IP40	BRYAN C IP40
TED C IP66	MIRIAM C DUAL IP40	EDWIN C IP66	BRYAN C IP66
TED CS		EDWIN C DUAL IP40	BRYAN CS
TED CT IP40			BRYAN CT IP40
TED CT IP66			BRYAN CT IP66
TED C DUAL IP40			BRYAN C DUAL IP40



InstallatiePlafond
Materialen
Roestvrij staal AISI 316

Afwerking
Gepolijst
Satijn
Wit Ral 9010Andere afwerkingen beschikbaar op aanvraag.

Lichtbron
Stroomvoorziening
Stroomverbruik
Absorptie
LED-bescherming
Polariteit gevoelig

LED
10 - 30 Vdc
2 W
0,17 A @ 12 V / 0,09 A @ 24 V
Beschermd tegen spanningspieken ± 500 V
Tegen omkering van polariteit
Ja

Kleurtemperatuur	Daglicht			Warm wit		
	3800-4100 K°			2900-3100 K° (2600-2800 K°*)		
CRI (kleurweergave-index)	≥ 80			≥ 80		
Lichtstroom	120 lm			110 lm		
Afstand	1 m	2 m	3 m	1 m	2 m	3 m
Diameter	2,31 m	4,61 m	6,92 m	2,31 m	4,61 m	6,92 m
Verlichtingssterkte	49,1 lux	12,3 lux	5,5 lux	40,8 lux	10,2 lux	4,5 lux
Straal	100°			100°		

*Op aanvraag beschikbaar

LED SPOTS

CLUB SERIES

TED C - IP40



TED C - 2W - IP40

Veerbevestiging

Ø Kroonlijst 72 mm
Nis 16 mm
Ø Uitsparing 54 mm



2W + Gekleurde sfeerverlichting

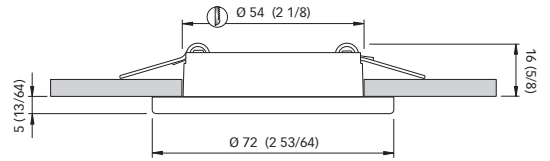

TED C - IP66



TED C - 2W - IP66

Schroefbevestiging

Ø Kroonlijst 72 mm
Nis 14 mm
Ø Uitsparing 54 mm



2W + Gekleurde sfeerverlichting

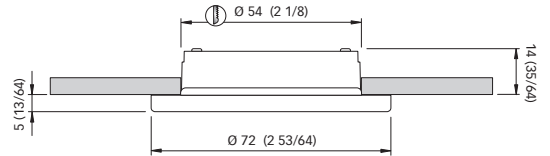

TED CS - IP40



TED CS - 2W - IP40

Veerbevestiging

Ø Kroonlijst 72 mm
Nis 16 mm
Ø Uitsparing 54 mm

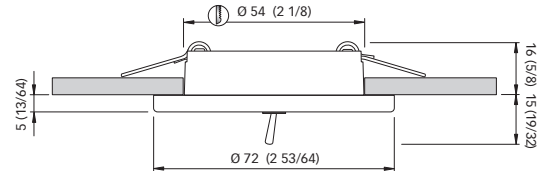

TED CT - IP40



TED CT - 2W - IP40

Veerbevestiging

Ø Kroonlijst 72 mm
Nis 16 mm
Ø Uitsparing 54 mm

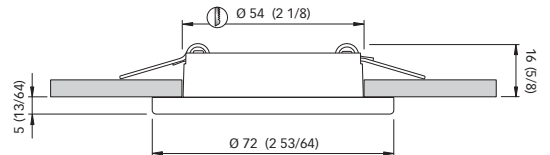

TED CT - IP66



TED CT - 2W - IP66

Schroefbevestiging

Ø Kroonlijst 72 mm
Nis 14 mm
Ø Uitsparing 54 mm

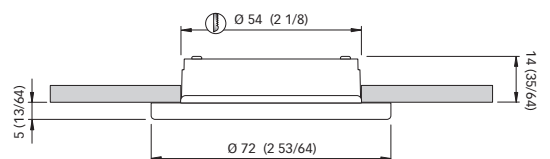

TED C DUAL - IP40



TED C DUAL - 2W+2W - IP40

Veerbevestiging

Ø Kroonlijst 72 mm
Nis 16 mm
Ø Uitsparing 54 mm

2W + 2W Dubbel licht

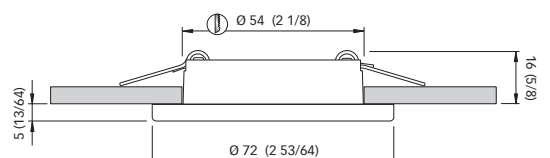

TED C DUAL - IP66



TED C DUAL - 2W+2W - IP66

Schroefbevestiging

Ø Kroonlijst 72 mm
Nis 14 mm
Ø Uitsparing 54 mm

2W + 2W Dubbel licht

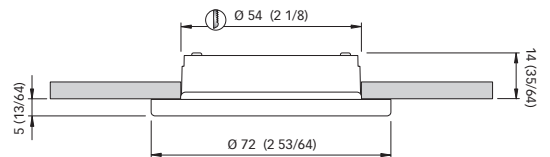

Afmetingen - mm (inch)

LED SPOTS

CLUB SERIES

MIRIAM C - IP40



IP40



MIRIAM C - 2W - IP40

Veerbevestiging

Ø Kroonlijst	77 mm
Nis	16 mm
Ø Uitsparing	54 mm



2W + Gekleurde sfeerverlichting

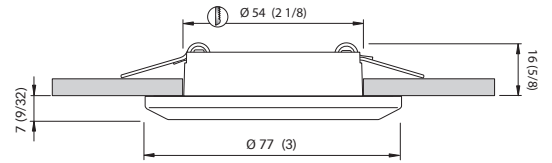

SELENE C - IP40



IP40

SELENE C - 2W - IP40

Veerbevestiging

Ø Kroonlijst	77 mm
Nis	16 mm
Ø Uitsparing	54 mm

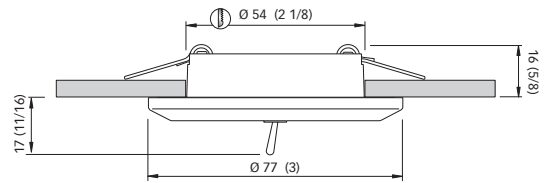

Afmetingen- mm (inch)

EDWIN C - IP40



IP40



EDWIN C - 2W - IP40

Veerbevestiging

Ø Kroonlijst	72 mm
Nis	16 mm
Ø Uitsparing	54 mm



2W + Gekleurde sfeerverlichting

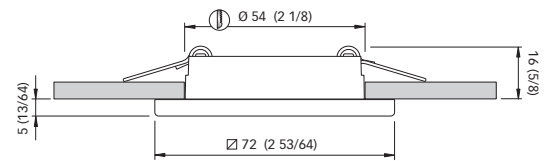

EDWIN C - IP66



IP66



EDWIN C - 2W - IP66

Schroefbevestiging

Ø Kroonlijst	72 mm
Nis	14 mm
Ø Uitsparing	54 mm



2W + Gekleurde sfeerverlichting

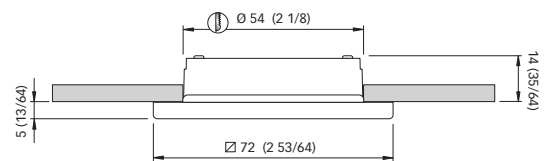

EDWIN C DUAL - IP40



IP40



EDWIN C DUAL - 2W+2W - IP40

Veerbevestiging

Ø Kroonlijst	72 mm
Nis	16 mm
Ø Uitsparing	54 mm

2W + 2W Dubbel licht

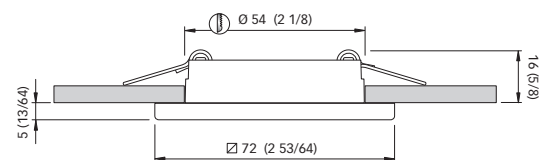

EDWIN C DUAL - IP66



IP66



EDWIN C DUAL - 2W+2W - IP66

Schroefbevestiging

Ø Kroonlijst	72 mm
Nis	14 mm
Ø Uitsparing	54 mm

2W + 2W Dubbel licht

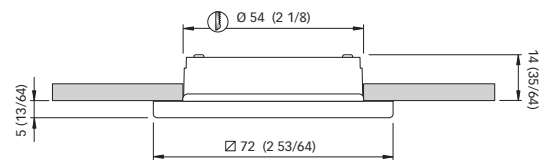

Afmetingen- mm (inch)

LED SPOTS

CLUB SERIES

BRYAN C - IP40



BRYAN C - 2W - IP40

Veerbevestiging

Ø Kroonlijst 72 mm
Nis 16 mm
Ø Uitsparing 54 mm



2W + Gekleurde sfeerverlichting

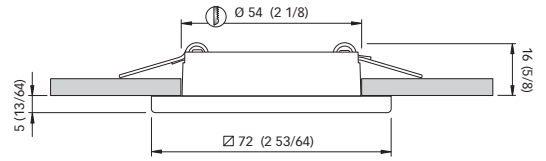

BRYAN C - IP66



BRYAN C - 2W - IP66

Schroefbevestiging

Ø Kroonlijst 72 mm
Nis 14 mm
Ø Uitsparing 54 mm



2W + Gekleurde sfeerverlichting

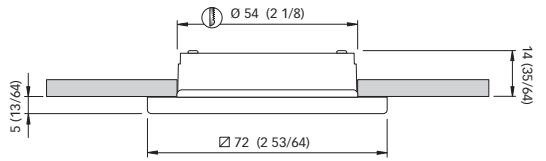

BRYAN CS - IP40



BRYAN CS - 2W - IP40

Veerbevestiging

Ø Kroonlijst 72 mm
Nis 16 mm
Ø Uitsparing 54 mm

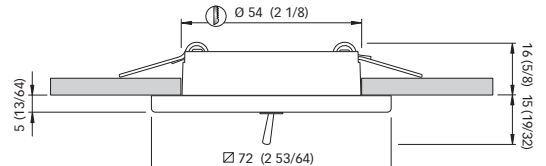

BRYAN CT - IP40



BRYAN CT - 2W - IP40

Veerbevestiging

Ø Kroonlijst 72 mm
Nis 16 mm
Ø Uitsparing 54 mm

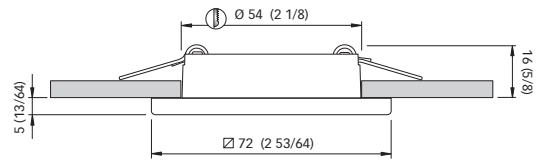

BRYAN CT - IP66



BRYAN CT - 2W - IP66

Schroefbevestiging

Ø Kroonlijst 72 mm
Nis 14 mm
Ø Uitsparing 54 mm

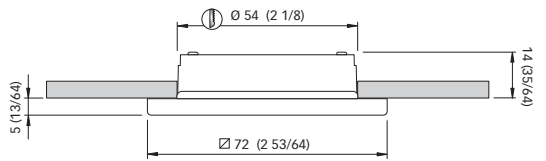

BRYAN C DUAL - IP40



BRYAN C DUAL - 2W+2W - IP40

Veerbevestiging

Ø Kroonlijst 72 mm
Nis 16 mm
Ø Uitsparing 54 mm

2W + 2W Dubbel licht

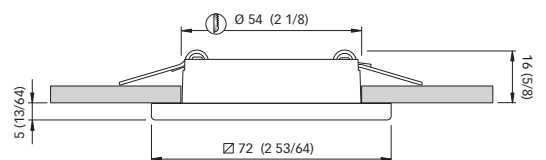

BRYAN C DUAL - IP66



BRYAN C DUAL - 2W+2W - IP66

Schroefbevestiging

Ø Kroonlijst 72 mm
Nis 14 mm
Ø Uitsparing 54 mm

2W + 2W Dubbel licht

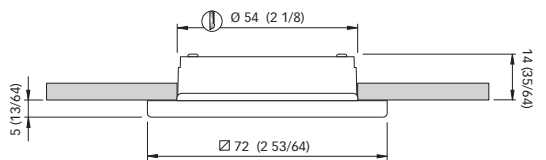

Afmetingen- mm (inch)

LED SPOTS

NICE SERIES



Samengesteld materiaal

Wit
Gemetalliseerd titanium

NICE (N)

Model 2WIP40/IP66
Dimbaar

Lichte kleur
Daglicht
Warm- wit
Blauw- rood
Meerkleurig

2W wit licht + gekleurd Sfeerverlichting

Daglicht-blauw
Warm wit-blauw
Daglicht-rood
Warm wit-rood



NICE SWITCH (NS)

Model 2W met schakelaar
IP40
Niet dimbaar

Lichte kleur
Daglicht
Warm wit
Rood

NICE TOUCH (NT)

Model 2W met aanraakschakelaar
IP40/IP66
Dimbaar

Puls aanraking
Aan / uit en dimmer
Druk op schakelaar

Lichte kleur
Daglicht
Warm wit
Rood

NICE (N) DUAL

Tweekleurig model 2W + 2W
IP40/IP66
Dimbaar

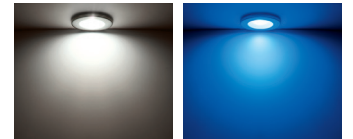

Dubbel licht

2W wit licht + 2W gekleurd licht
Daglicht-Blauw
Warm wit-blauw
Daglicht-rood
Warm wit-rood

MODELLEN INGEBOUWDE SPOTLIGHT-SERIE NICE

TED N IP40	EDWIN N IP40	BRYAN N IP40
TED N IP66	EDWIN N IP66	BRYAN N IP66
TED NS	EDWIN N DUAL IP40	BRYAN NS
TED NT IP40		BRYAN NT IP40
TED NT IP66		BRYAN NT IP66
TED N DUAL IP40		BRYAN N DUAL IP40



Installatie

Plafond

Materialen

Samengesteld materiaal

Afwerking

Wit
Gemetalliseerd titanium

Andere afwerkingen beschikbaar op aanvraag.

Lichtbron

Stroomvoorziening

Stroomverbruik

Absorptie

LED-bescherming

Polariteit gevoelig

LED

10 - 30 Vdc

2 W

0,17 A @ 12 V / 0,09 A @ 24 V

Beschermd tegen spanningspieken ± 500 V
Tegen omkering van polariteit

Ja

Kleurtemperatuur	Daglicht			Warm wit		
	3800-4100 K°			2900-3100 K° (2600-2800 K°*)		
CRI (kleurweergave-index)	≥ 80			≥ 80		
Lichtstroom	120 lm			110 lm		
Afstand	1 m	2 m	3 m	1 m	2 m	3 m
Diameter	2,31 m	4,61 m	6,92 m	2,31 m	4,61 m	6,92 m
Verlichtingssterkte	49,1 lux	12,3 lux	5,5 lux	40,8 lux	10,2 lux	4,5 lux
Straal	100°			100°		

*Op aanvraag beschikbaar

LED SPOTS

NICE SERIES

TED N - IP40



TED N - 2W - IP40

Veerbevestiging

Ø Kroonlijst 72 mm
Nis 16 mm
Ø Uitsparing 54 mm

○ ● ● ● ●
2W + Gekleurde sfeerverlichting
○ ● ● ● ●

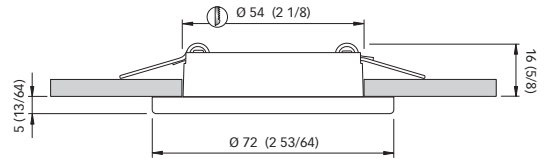

TED N - IP66



TED N - 2W - IP66

Schroefbevestiging

Ø Kroonlijst 72 mm
Nis 14 mm
Ø Uitsparing 54 mm

○ ● ● ● ●
2W + Gekleurde sfeerverlichting
○ ● ● ● ●

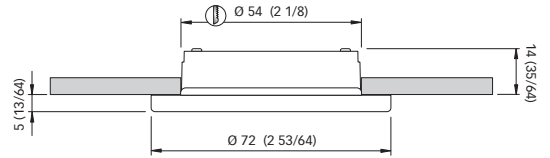

TED NT - IP40



TED NT - 2W - IP40

Veerbevestiging

Ø Kroonlijst 72 mm
Nis 16 mm
Ø Uitsparing 54 mm

○ ● ● ● ●

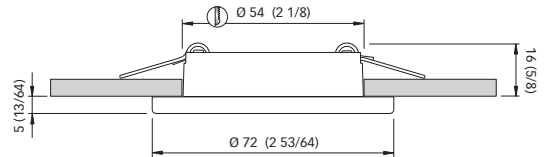

TED NT - IP66



TED NT - 2W - IP66

Schroefbevestiging

Ø Kroonlijst 72 mm
Nis 14 mm
Ø Uitsparing 54 mm

○ ● ● ● ●

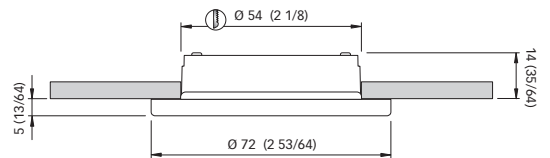

TED N DUAL - IP40



TED N DUAL - 2W+2W - IP40

Veerbevestiging

Ø Kroonlijst 72 mm
Nis 16 mm
Ø Uitsparing 54 mm

2W + 2W Dubbel licht ○ ● ● ● ●

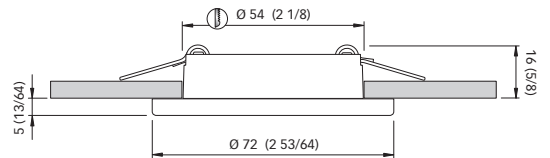

TED N DUAL - IP66



TED N DUAL - 2W+2W - IP66

Schroefbevestiging

Ø Kroonlijst 72 mm
Nis 14 mm
Ø Uitsparing 54 mm

2W + 2W Dubbel licht ○ ● ● ● ●

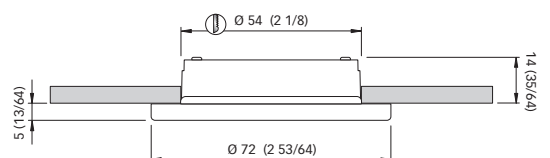

Afmetingen - mm (inch)

LED SPOTS

NICE SERIES

EDWIN N - IP40



IP40



EDWIN N - 2W - IP40

Veerbevestiging

Ø Kroonlijst 72 mm
Nis 16 mm
Ø Uitsparing 54 mm

2W + Gekleurde sfeerverlichting



EDWIN N - IP66



IP66



EDWIN N - 2W - IP66

Schroefbevestiging

Ø Kroonlijst 72 mm
Nis 14 mm
Ø Uitsparing 54 mm

2W + Gekleurde sfeerverlichting



EDWIN N DUAL - IP40



IP40



EDWIN N DUAL - 2W+2W - IP40

Veerbevestiging

Ø Kroonlijst 72 mm
Nis 16 mm
Ø Uitsparing 54 mm

2W + 2W Dubbel licht



EDWIN N DUAL - IP66



IP66



EDWIN N DUAL - 2W+2W - IP66

Schroefbevestiging

Ø Kroonlijst 72 mm
Nis 14 mm
Ø Uitsparing 54 mm

2W + 2W Dubbel licht

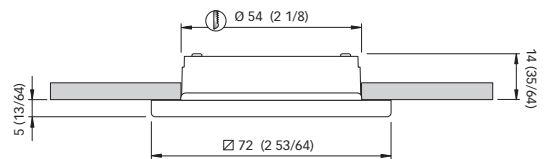
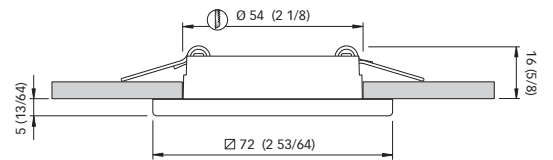
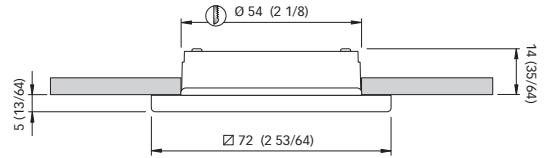
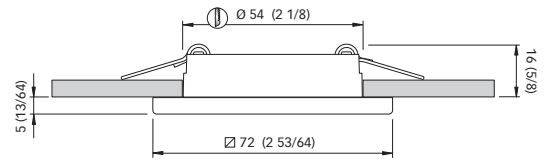

Afmetingen- mm (inch)

LED SPOTS

NICE SERIES

BRYAN N - IP40



BRYAN N - 2W - IP40

Veerbevestiging

Ø Kroonlijst 72 mm
Nis 16 mm
Ø Uitsparing 54 mm

○ ● ● ● ●
2W + Gekleurde sfeerverlichting
● ● ● ● ●

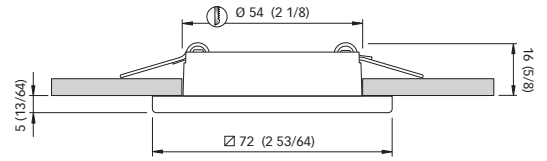

BRYAN N - IP66



BRYAN N - 2W - IP66

Schroefbevestiging

Ø Kroonlijst 72 mm
Nis 14 mm
Ø Uitsparing 54 mm

○ ● ● ● ●
2W + Gekleurde sfeerverlichting
● ● ● ● ●

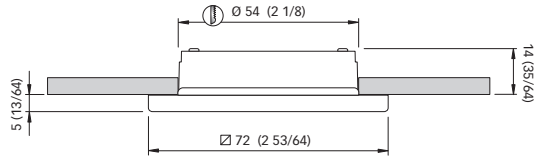

BRYAN NT - IP40



BRYAN NT - 2W - IP40

Veerbevestiging

Ø Kroonlijst 72 mm
Nis 16 mm
Ø Uitsparing 54 mm

○ ● ● ● ●

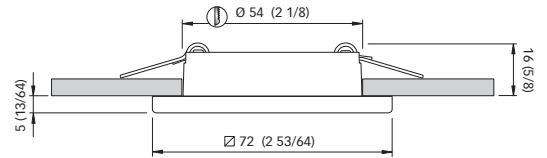

BRYAN NT - IP66



BRYAN NT - 2W - IP66

Schroefbevestiging

Ø Kroonlijst 72 mm
Nis 14 mm
Ø Uitsparing 54 mm

○ ● ● ● ●

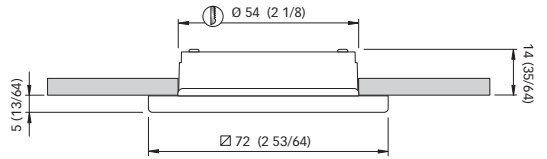

BRYAN N DUAL - IP40



BRYAN N DUAL - 2W+2W - IP40

Veerbevestiging

Ø Kroonlijst 72 mm
Nis 16 mm
Ø Uitsparing 54 mm

2W + 2W Dubbel licht ● ● ● ● ●

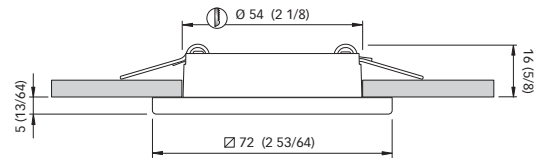

BRYAN N DUAL - IP66



BRYAN N DUAL - 2W+2W - IP66

Schroefbevestiging

Ø Kroonlijst 72 mm
Nis 14 mm
Ø Uitsparing 54 mm

2W + 2W Dubbel licht ● ● ● ● ●

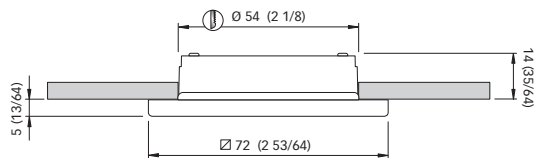

Afmetingen - mm (inch)

LED SPOTS

VIP SERIES



AISI 316 Roestvrij staal

Gepolijst
Satijn
Ral 9010

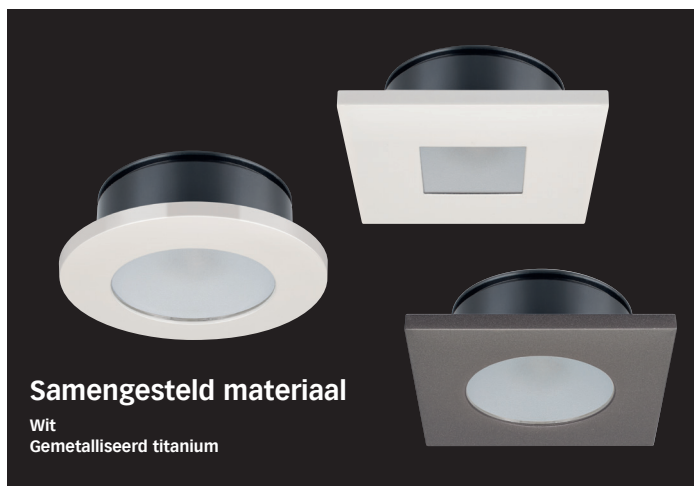

Samengesteld materiaal

Wit
Gemetalliseerd titanium

VIP (V)

Model 4W
IP66

Dimbaar

Lichte kleur

Daglicht
Warm wit
BlauwRood
4W wit licht + gekleurde hoffelijkheidlicht
Daglicht-blauw
Warm wit-blauw
Daglicht-rood
Warm wit-rood

MODELLI VIP / VIP MODELS

TED V IP66
EDWIN V IP66
BRYAN V IP66

Installatie

Plafond

Materialen

Roestvrij staal AISI 316

Afwerking

Gepolijst
Satijn
Wit Ral 9010
Andere afwerkingen beschikbaar op aanvraag.

VIP NICE (VN)

Model 4W
IP66

Dimbaar

Lichte kleur

Daglicht
Warm wit
BlauwRood
4W wit licht + gekleurde hoffelijkheidlicht
Daglicht-blauw
Warm wit-blauw
Daglicht-rood
Warm wit-rood

VIP NICE MODELLEN

TED VN IP66
EDWIN VN IP66
BRYAN VN IP66

Installatie

Plafond

Materialen

Samengesteld materiaal

Afwerking

Wit
Gemetalliseerd titanium
Andere afwerkingen beschikbaar op aanvraag



Modellen	TED V/VN - BRYAN V/VN						EDWIN V/VN					
	LED						LED					
Lichtbron	10 - 30 Vdc						10 - 30 Vdc					
Stroomvoorziening	4 W						4 W					
Stroomverbruik	0,33 A @ 12 V / 0,17 A @ 24 V						0,33 A @ 12 V / 0,17 A @ 24 V					
Absorptie	Beschermd tegen spanningspieken ± 500 V - Tegen omkering van polariteit						Beschermd tegen spanningspieken ± 500 V - Tegen omkering van polariteit					
LED-bescherming	Ja						Ja					
Polariteit gevoelig	Ja						Ja					
Kleurtemperatuur	Daglicht			Warm wit			Daglicht			Warm wit		
	3800-4100 K°			2900-3100 K° (2600-2800 K°*)			3800-4100 K°			2900-3100 K° (2600-2800 K°*)		
CRI (kleurweergave-index)	≥ 80			≥ 80			≥ 80			≥ 80		
Lichtstroom	285 lm			255 lm			200 lm			190 lm		
Afstand	1 m	2 m	3 m	1 m	2 m	3 m	1 m	2 m	3 m	1 m	2 m	3 m
Diameter	2,17 m	4,34 m	6,51 m	2,17 m	4,34 m	6,51 m	1,69 m	3,39 m	5,08 m	1,69 m	3,39 m	5,08 m
Verlichtingssterkte	122,8 lux	30,7 lux	13,6 lux	116,0 lux	29,0 lux	12,9 lux	114,4 lux	28,6 lux	12,7 lux	110,0 lux	27,5 lux	12,2 lux
Straal	95°			95°			80°			80°		

*Op aanvraag beschikbaar

LED SPOTS

VIP SERIES

TED V - 4W - IP66



TED V - 4W - IP66 Schroefbevestiging

Ø Kroonlijst 72 mm
Nis 20,5 mm
Ø Uitsparing 54 mm

4W + Gekleurde sfeerverlichting



Afmetingen- mm (inch)

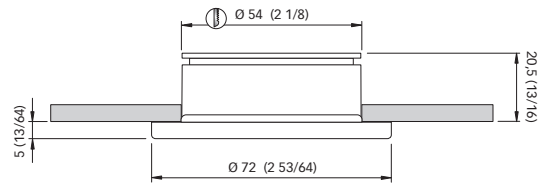

EDWIN V - 4W - IP66



EDWIN V - 4W - IP66 Schroefbevestiging

Ø Kroonlijst 72 mm
Nis 20,5 mm
Ø Uitsparing 54 mm

4W + Gekleurde sfeerverlichting

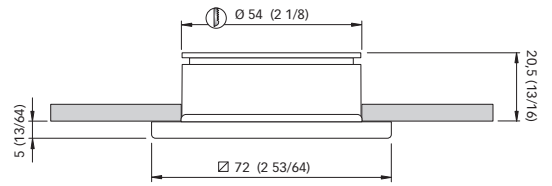

BRYAN V - 4W - IP66



BRYAN V - 4W - IP66 Schroefbevestiging

Ø Kroonlijst 72 mm
Nis 20,5 mm
Ø Uitsparing 54 mm

4W + Gekleurde sfeerverlichting

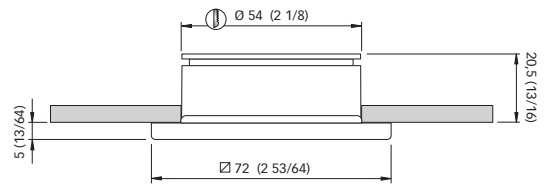

TED VN - 4W - IP66



TED VN - 4W - IP66 Schroefbevestiging

Ø Kroonlijst 72 mm
Nis 20,5 mm
Ø Uitsparing 54 mm

4W + Gekleurde sfeerverlichting

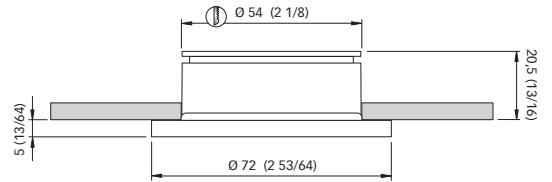

EDWIN VN - 4W - IP66



EDWIN VN - 4W - IP66 Schroefbevestiging

Ø Kroonlijst 72 mm
Nis 20,5 mm
Ø Uitsparing 54 mm

4W + Gekleurde sfeerverlichting

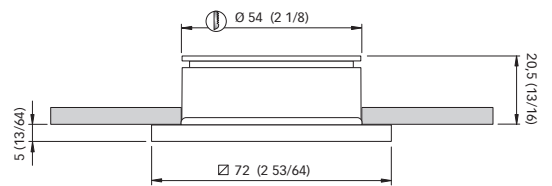

BRYAN VN - 4W - IP66



BRYAN VN - 4W - IP66 Schroefbevestiging

Ø Kroonlijst 72 mm
Nis 20,5 mm
Ø Uitsparing 54 mm

4W + Gekleurde sfeerverlichting

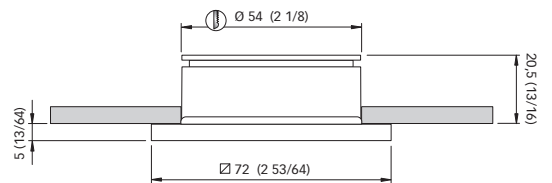

VIP series inclusief de gekleurde sfeerverlichting VENUS V 4W (zie pagina 124)

LED SPOTS

XP SERIES



XP LP 4W

4W model - IP66 - Spring Installatie

Dimbaar

Lichte kleur

Daglicht
Warm wit
Blauw-rood
Meerkleurig

4W wit licht + gekleurde hoffelijkheidlicht

Daglicht-blauw
Warm wit-blauw
Daglicht-rood
Warm wit-rood

XP HP 4W

4W model - IP66 - Schroefinstallatie

Dimbaar

Lichte kleur

Daglicht
Warm wit
Blauw-rood
Meerkleurig

4W wit licht + gekleurde hoffelijkheidlicht

Daglicht-blauw
Warm wit-blauw
Daglicht-rood
Warm wit-rood

XP LP 6W

6W model - IP66 - Springinstallatie

Dimbaar

Lichte kleur

Daglicht
Warm wit
Blauw- rood
Meerkleurig

6W wit licht + gekleurde hoffelijkheidlicht

Daglicht-blauw
Warm wit-blauw
Daglicht-rood
Warm wit-rood

XP HP 6W

6W model - IP66 - Schroefinstallatie

Dimbaar

Lichte kleur

Daglicht
Warm wit
Blauw-rood
Meerkleurig

6W wit licht + gekleurde hoffelijkheid

Lichtdaglicht-blauw
Warm wit-blauw
Daglicht-rood
Warm wit-rood

RGBW (Quick kleurcontrolesysteem)

RGBW (Quick kleurcontrolesysteem)

Installatie

Plafond

Materialen

Roestvrij staal AISI 316

Afwerking

Gepolijst
Satijn
Wit Ral 9010 Andere afwerkingen beschikbaar op aanvraag.

MODELLEN VAN DE CLUB-SERIE

KAI XP LP 4W MARINA XP LP 4W
KAI XP HP 4W MARINA XP HP 4W
KAI XP LP 6W MARINA XP LP 6W
KAI XP HP 6W MARINA XP HP 6W

KOR XP LP 4W BLAKE XP LP 4W
KOR XP HP 4W BLAKE XP HP 4W
KOR XP LP 6W BLAKE XP LP 6W
KOR XP HP 6W BLAKE XP HP 6W



IP66



LP Versie

IP66



HP Versie



Quick RGBW-systeem met

De XP-serie is beschikbaar in de RGBW-versie en kan worden bediend met het QCC Quick-systeem (pagina 149)



LED SPOTS

XP SERIES

KAI XP LP - 4W

CRI 90

Warm wit



IP66



KAI XP LP - 4W - IP66

Veerbevestiging

Ø Kroonlijst 82 mm
Nis 30 mm
Ø Uitsparing 65 mm

4W + Gekleurde sfeerverlichting

Afmetingen- mm (inch)

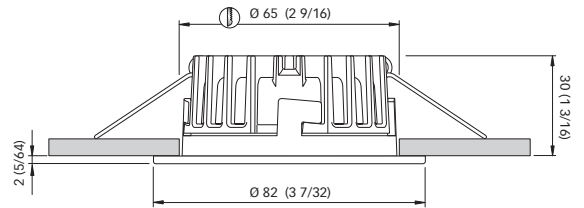

KAI XP HP - 4W

CRI 90

Warm wit



IP66



KAI XP HP - 4W - IP66

Schroefbevestiging

Ø Kroonlijst 82 mm
Nis 28 mm
Ø Uitsparing 65 mm

4W + Gekleurde sfeerverlichting

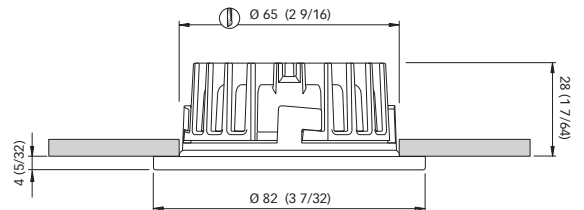

KAI XP LP - 6W

CRI 90

Warm wit



IP66



KAI XP LP - 6W - IP66

Veerbevestiging

Ø Kroonlijst 82 mm
Nis 30 mm
Ø Uitsparing 65 mm

6W + Gekleurde sfeerverlichting

KAI XP LP - 6W - IP66

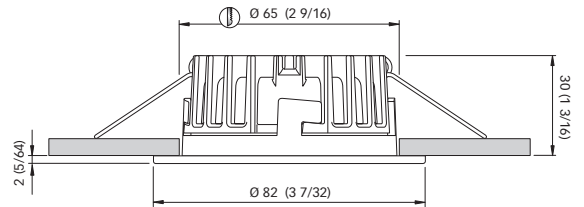

KAI XP HP - 6W

CRI 90

Warm wit



IP66



KAI XP HP - 6W - IP66

Schroefbevestiging

Ø Kroonlijst 82 mm
Nis 28 mm
Ø Uitsparing 65 mm

6W + Gekleurde sfeerverlichting

KAI XP HP - 6W - IP66

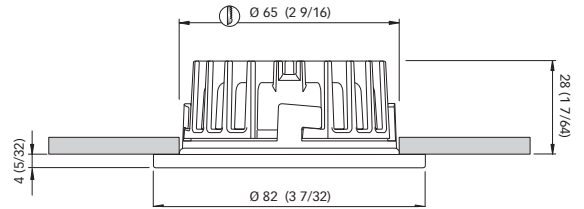

Modellen	KAI XP LP/HP - 4 WATT	KAI XP LP/HP - 6 WATT
Lichtbron	LED	LED
Stroomvoorziening	10 - 30 Vdc	10 - 30 Vdc
Stroomverbruik	4 W	6 W
Absorptie	0,33 A @ 12 V / 0,17 A @ 24 V	0,5 A @ 12 V / 0,25 A @ 24 V
LED-bescherming	Beschermd tegen spanningspieken ± 500 V - Tegen omkering van polariteit	
Polariteit gevoelig	Ja	

Kleurtemperatuur	Daglicht			Warm wit			Daglicht			Warm wit		
	3800-4100 K°			2900-3100 K° (2600-2800 K°*)			3800-4100 K°			2900-3100 K° (2600-2800 K°*)		
CRI (kleurweergave-index)	≥ 80			≥ 90			≥ 80			≥ 90		
Lichtstroom	310 lm			240 lm			410 lm			315 lm		
Afstand	1 m	2 m	3 m	1 m	2 m	3 m	1 m	2 m	3 m	1 m	2 m	3 m
Diameter	1,48 m	2,97 m	4,45 m	1,48 m	2,97 m	4,45 m	1,48 m	2,97 m	4,45 m	1,48 m	2,97 m	4,45 m
Verlichtingssterkte	187,4 lux	46,9 lux	20,8 lux	137,9 lux	34,5 lux	15,3 lux	263,4 lux	65,9 lux	29,3 lux	193,8 lux	48,4 lux	21,5 lux
Straal	70°			70°			70°			70°		

*Op aanvraag beschikbaar

LED SPOTS

XP SERIES

Afmetingen- mm (inch)

KOR XP LP - 4W

CRI 90 Warm wit



KOR XP LP - 4W - IP66

Veerbevestiging
 Ø Kroonlijst 82 mm
 Nis 30 mm
 Ø Uitsparing 65 mm

4W + Gekleurde sfeerverlichting

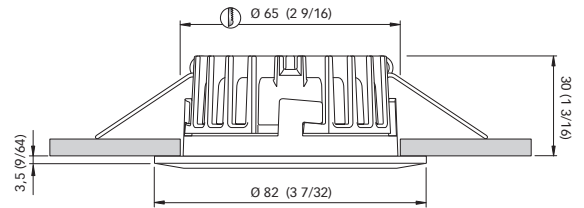

KOR XP HP - 4W

CRI 90 Warm wit



KOR XP HP - 4W - IP66

Schroefbevestiging
 Ø Kroonlijst 82 mm
 Nis 28 mm
 Ø Uitsparing 65 mm

4W + Gekleurde sfeerverlichting

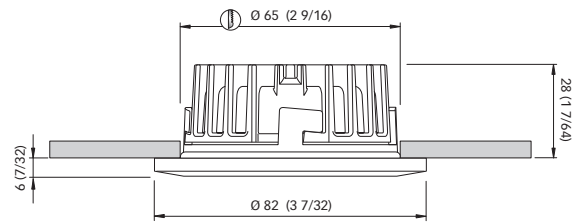

KOR XP LP - 6W

CRI 90 Warm wit



KOR XP LP - 6W - IP66

Veerbevestiging
 Ø Kroonlijst 82 mm
 Nis 30 mm
 Ø Uitsparing 65 mm

6W + Gekleurde sfeerverlichting

KOR XP LP - 6W - IP66

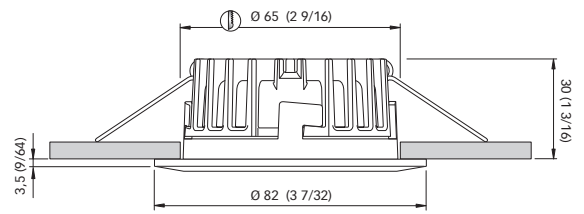

KOR XP HP - 6W

CRI 90 Warm wit



KOR XP HP - 6W - IP66

Schroefbevestiging
 Ø Kroonlijst 82 mm
 Nis 28 mm
 Ø Uitsparing 65 mm

6W + Gekleurde sfeerverlichting

KOR XP HP - 6W - IP66

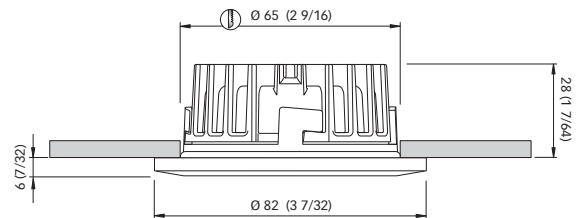

Modellen	KOR XP LP/HP - 4 WATT	KOR XP LP/HP - 6 WATT
Lichtbron	LED	LED
Stroomvoorziening	10 - 30 Vdc	10 - 30 Vdc
Stroomverbruik	4 W	6 W
Absorptie	0,33 A @ 12 V / 0,17 A @ 24 V	0,5 A @ 12 V / 0,25 A @ 24 V
LED-bescherming	Beschermd tegen spanningspieken ± 500 V - Tegen omkering van polariteit	
Polariteit gevoelig	Ja	

Kleurtemperatuur	Daglicht			Warm wit		
	3800-4100 K*			2900-3100 K* (2600-2800 K**)		
CRI (kleurweergave-index)	≥ 80			≥ 90		
Lichtstroom	310 lm			240 lm		
Afstand	1 m	2 m	3 m	1 m	2 m	3 m
Diameter	1,48 m	2,97 m	4,45 m	1,48 m	2,97 m	4,45 m
Verlichtingssterkte	187,4 lux	46,9 lux	20,8 lux	137,9 lux	34,5 lux	15,3 lux
Straal	70°			70°		
	1 m	2 m	3 m	1 m	2 m	3 m
	1,48 m	2,97 m	4,45 m	1,48 m	2,97 m	4,45 m
	263,4 lux	65,9 lux	29,3 lux	193,8 lux	48,4 lux	21,5 lux
	70°			70°		

*Op aanvraag beschikbaar

LED SPOTS

XP SERIES

MARINA XP LP - 4W

CRI 90

Warm wit



IP66



MARINA XP LP - 4W - IP66

Veerbevestiging

Zijrand 79 mm
Nis 30 mm
Ø Uitsparing 65 mm

4W + Gekleurde sfeerverlichting



Afmetingen- mm (inch)

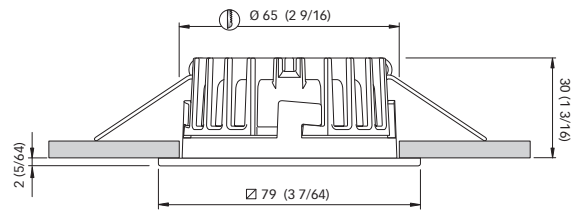

MARINA XP HP - 4W

CRI 90

Warm wit



IP66



MARINA XP HP - 4W - IP66

Schroefbevestiging

Zijrand 79 mm
Nis 28 mm
Ø Uitsparing 65 mm

4W + Gekleurde sfeerverlichting

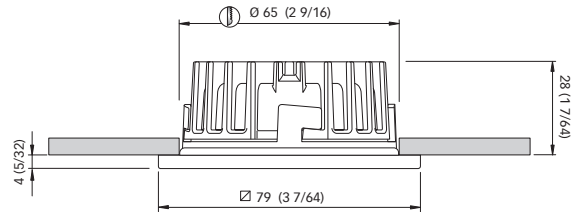

MARINA XP LP - 6W

CRI 90

Warm wit



IP66



MARINA XP LP - 6W - IP66

Veerbevestiging

Zijrand 79 mm
Nis 30 mm
Ø Uitsparing 65 mm

6W + Gekleurde sfeerverlichting



MARINA XP LP - 6W - IP66

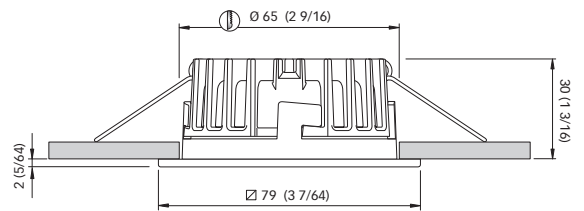

MARINA XP HP - 6W

CRI 90

Warm wit



IP66



MARINA XP HP - 6W - IP66

Schroefbevestiging

Zijrand 79 mm
Nis 28 mm
Ø Uitsparing 65 mm

6W + Gekleurde sfeerverlichting



MARINA XP HP - 6W - IP66

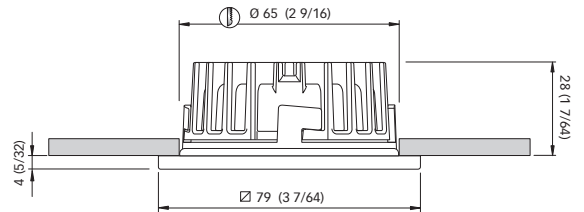

Modellen	MARINA XP LP/HP - 4 WATT	MARINA XP LP/HP - 6 WATT
Lichtbron	LED	LED
Stroomvoorziening	10 - 30 Vdc	10 - 30 Vdc
Stroomverbruik	4 W	6 W
Absorptie	0,33 A @ 12 V / 0,17 A @ 24 V	0,5 A @ 12 V / 0,25 A @ 24 V
LED-bescherming	Beschermd tegen spanningspieken ± 500 V - Tegen omkering van polariteit	
Polariteit gevoelig	Ja	

Kleurtemperatuur	Daglicht			Warm wit		
	3800-4100 K°			2900-3100 K° (2600-2800 K°*)		
CRI (kleurweergave-index)	≥ 80			≥ 90		
Lichtstroom	295 lm			225 lm		
Afstand	1 m	2 m	3 m	1 m	2 m	3 m
Diameter	1,04 m	2,09 m	3,13 m	1,04 m	2,09 m	3,13 m
Verlichtingssterkte	283,4 lux	70,9 lux	31,5 lux	208,5 lux	52,1 lux	23,2 lux
Straal	55°			55°		
Kleurtemperatuur	Daglicht			Warm wit		
	3800-4100 K°			2900-3100 K° (2600-2800 K°*)		
CRI (kleurweergave-index)	≥ 80			≥ 90		
Lichtstroom	395 lm			305 lm		
Afstand	1 m	2 m	3 m	1 m	2 m	3 m
Diameter	1,02 m	2,03 m	3,05 m	1,02 m	2,03 m	3,05 m
Verlichtingssterkte	386,5 lux	96,6 lux	42,9 lux	284,3 lux	74,1 lux	31,6 lux
Straal	55°			55°		

*Op aanvraag beschikbaar

LED SPOTS

XP SERIES

Afmetingen- mm (inch)

BLAKE XP LP - 4W

CRI 90

Warm wit



IP66

BLAKE XP LP - 4W - IP66

Veerbevestiging

Zijrand 79 mm
Nis 30 mm
Ø Uitsparing 65 mm

4W + Gekleurde sfeerverlichting

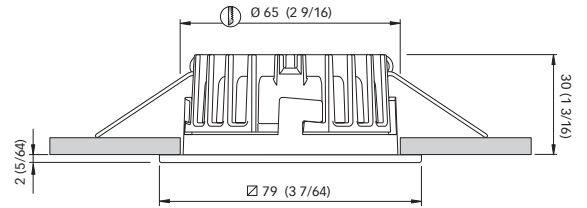

BLAKE XP HP - 4W

CRI 90

Warm wit



IP66

BLAKE XP HP - 4W - IP66

Schroefbevestiging

Zijrand 79 mm
Nis 28 mm
Ø Uitsparing 65 mm

4W + Gekleurde sfeerverlichting

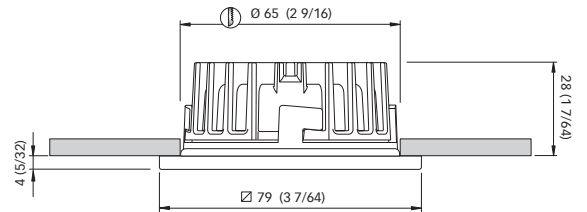

BLAKE XP LP - 6W

CRI 90

Warm wit



IP66

BLAKE XP LP - 6W - IP66

Veerbevestiging

Zijrand 79 mm
Nis 30 mm
Ø Uitsparing 65 mm

6W + Gekleurde sfeerverlichting

BLAKE XP LP - 6W - IP66

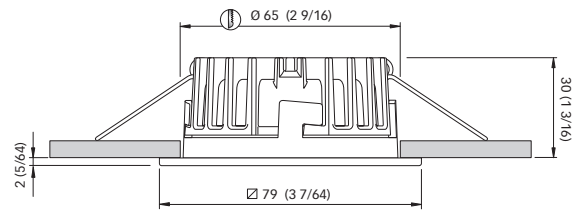

BLAKE XP HP - 6W

CRI 90

Warm wit



IP66

BLAKE XP HP - 6W - IP66

Schroefbevestiging

Zijrand 79 mm
Nis 28 mm
Ø Uitsparing 65 mm

6W + Gekleurde sfeerverlichting

BLAKE XP HP - 6W - IP66

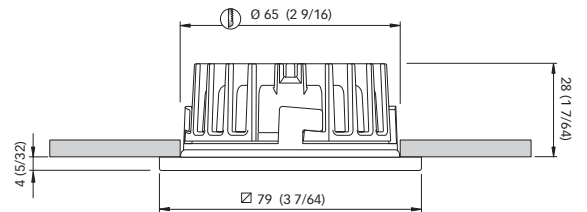

Modellen	BLAKE XP LP/HP - 4 WATT	BLAKE XP LP/HP - 6 WATT
Lichtbron	LED	LED
Stroomvoorziening	10 - 30 Vdc	10 - 30 Vdc
Stroomverbruik	4 W	6 W
Absorptie	0,33 A @ 12 V / 0,17 A @ 24 V	0,5 A @ 12 V / 0,25 A @ 24 V
LED-bescherming	Beschermd tegen spanningspieken ± 500 V - Tegen omkering van polariteit	
Polariteit gevoelig	Ja	

Kleurtemperatuur	Daglicht			Warm wit		
	3800-4100 K°			2900-3100 K° (2600-2800 K°**)		
CRI (kleurweergave-index)	≥ 80			≥ 90		
Lichtstroom	310 lm			240 lm		
Afstand	1 m	2 m	3 m	1 m	2 m	3 m
Diameter	1,48 m	2,97 m	4,45 m	1,48 m	2,97 m	4,45 m
Verlichtingssterkte	187,4 lux	46,9 lux	20,8 lux	137,9 lux	34,5 lux	15,3 lux
Straal	70°			70°		
	70°			70°		
	70°			70°		

*Op aanvraag beschikbaar

LED SPOTS

VERSTELBAAR



Adjustable



VERSTELBAAR

Gepolijst
Satijn
Ral 9010

YOKO

Adjustable



IP40



YOKO
Veerbevestiging
Ø Kroonlijst
Nis
Ø Uitsparing

65 mm
35 mm
52 mm



Afmetingen- mm (inch)

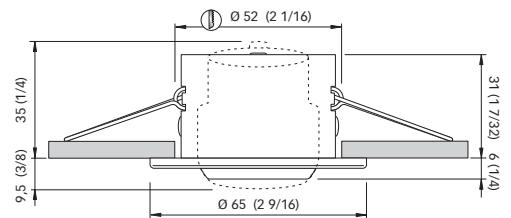

LUCILLE

Adjustable



IP40



LUCILLE
Veerbevestiging
Ø Kroonlijst
Nis
Ø Uitsparing

65 mm
35 mm
52 mm

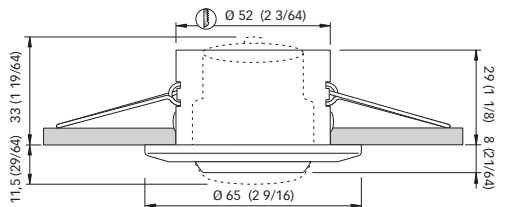

Installatie
Dimbaar

Materialen
Roestvrij staal AISI 316

Afwerking
Gepolijst
Satijn
Wit Ral 9010
Andere afwerkingen beschikbaar op aanvraag.

Lichtbron
Stroomvoorziening
Stroomverbruik
Absorptie
LED-bescherming
Polariteit gevoelig

LED
10 - 30 Vdc
1,5 W
0,12 A @ 12 V / 0,06 A @ 24 V
Beschermd tegen spanningspieken ± 500 V
No



Kleurtemperatuur	Daglicht			Warm wit		
	3800-4100 K°			2900-3100 K° (2600-2800 K°*)		
CRI (kleurweergave-index)	≥ 80			≥ 80		
Lichtstroom	42 lm			40 lm		
Afstand	1 m	2 m	3 m	1 m	2 m	3 m
Diameter	0,57 m	1,15 m	1,72 m	0,57 m	1,15 m	1,72 m
Verlichtingssterkte	78,14 lux	19,54 lux	8,68 lux	73,7 lux	18,4 lux	8,2 lux
Straal	30°			30°		

*Op aanvraag beschikbaar

LED SPOTS

VERSTELBAAR

NIKITA 4W

Adjustable
∞



NIKITA 4W
Veerbevestiging
 Ø Kroonlijst 85 mm
 Nis 42 mm
 Ø Uitsparing 70 mm

● ●
4W + Gekleurde sfeerverlichting
 ● ● ● ●

Afmetingen- mm (inch)

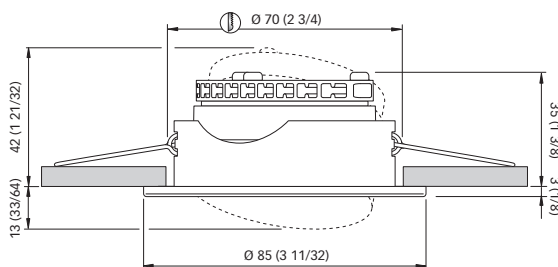

NIKITA 9W

Adjustable
∞



NIKITA 9W
Veerbevestiging
 Ø Kroonlijst 85 mm
 Nis 71 mm
 Ø Uitsparing 70 mm

● ●
9W + Gekleurde sfeerverlichting
 ● ● ● ●

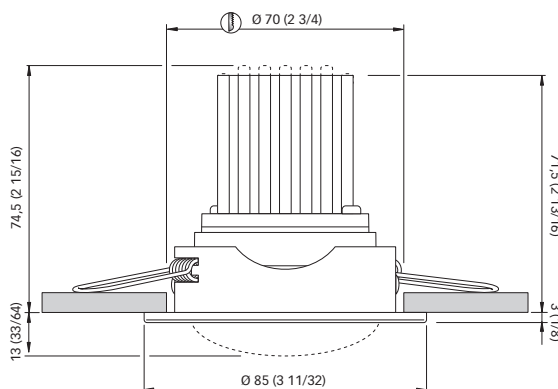

Installatie
 Plafond
Dimbaar

Materialen
 Roestvrij staal AISI 316

Afwerking
 Gepolijst
 Satijn
 Wit Wit Ral 9010
 Andere afwerkingen beschikbaar op aanvraag.

NIKITA 4W - OPTIONAL ACCESSOIRES, Nikita 4 Watt inbouwspotsframes



NK L1

NK L2

NK L3

De NK-lijn is gemaakt om op de Nikita-inbouwspots te passen. Nikita inbouwspots zijn niet inbegrepen in de verpakking.

IP40

Modellen	NIKITA 4 WATT			NIKITA 9 WATT		
Lichtbron	LED			LED		
Stroomvoorziening	10 - 30 Vdc			10 - 30 Vdc		
Stroomverbruik	4 W			9 W		
Absorptie	0,3 A @ 12 V / 0,16 A @ 24 V			0,75 A @ 12 V / 0,38 A @ 24 V		
LED-bescherming	Beschermd tegen spanningsspieken ± 500 V Tegen omkering van polariteit					
Polariteit gevoelig	Ja					

Kleurtemperatuur	Daglicht			Warm wit			Daglicht			Warm wit		
	3800-4100 K°			2900-3100 K° (2600-2800 K°*)			3800-4100 K°			2900-3100 K° (2600-2800 K°*)		
CRI (kleurweergave-index)	≥ 80			≥ 80			≥ 80			≥ 90		
Lichtstroom	260 lm			235 lm			388 lm			359 lm		
Afstand	1 m	2 m	3 m	1 m	2 m	3 m	1 m	2 m	3 m	1 m	2 m	3 m
Diameter	0,74 m	1,49 m	2,23 m	0,74 m	1,49 m	2,23 m	0,79 m	1,58 m	2,37 m	0,79 m	1,58 m	2,37 m
Verlichtingssterkte	273,6 lux	68,4 lux	30,4 lux	252,8 lux	63,2 lux	28,1 lux	413,9 lux	103,5 lux	46 lux	383,2 lux	95,8 lux	42,6 lux
Straal	45°			45°			45°			45°		

*Op aanvraag beschikbaar

LED SPOTS

VERSTELBAAR

REGINA 4W

Adjustable



IP40



REGINA 4W
Veerbevestiging
 Zijrand 85 mm
 Nis 42 mm
 Ø Uitsparing 70 mm

● ●
4W + Gekleurde sfeerverlichting
 ● ● ● ●

Afmetingen- mm (inch)

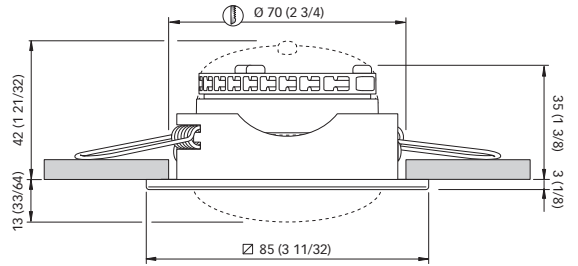

REGINA 9W

Adjustable



IP40



CRI 90
 WARM

REGINA 9W
Veerbevestiging
 Zijrand 85 mm
 Nis 71 mm
 Ø Uitsparing 70 mm

● ●
9W + Gekleurde sfeerverlichting
 ● ● ● ●

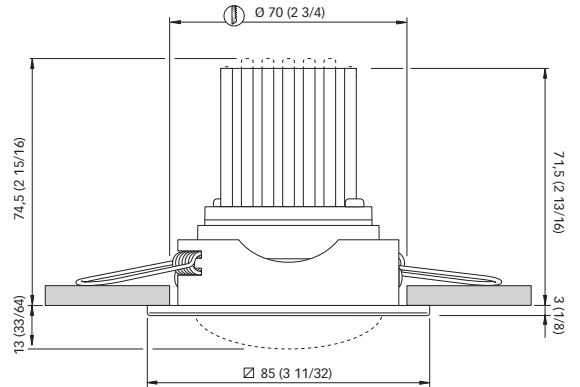

Installatie
 Plafond

Dimbaar

Materialen
 Roestvrij staal AISI 316

Afwerking
 Gepolijst
 Satijn
 Wit Ral 9010

Andere afwerkingen beschikbaar op aanvraag.

IP40

Modellen	REGINA 4 WATT						REGINA 9 WATT					
Lichtbron	LED						LED					
Stroomvoorziening	10 - 30 Vdc						10 - 30 Vdc					
Stroomverbruik	4 W						9 W					
Absorptie	0,3 A @ 12 V / 0,16 A @ 24 V						0,75 A @ 12 V / 0,38 A @ 24 V					
LED-bescherming	Beschermd tegen spanningspieken ± 500 V Tegen omkering van polariteit											
Polariteit gevoelig	Ja											

Kleurtemperatuur	Daglicht			Warm wit			Daglicht			Warm wit		
	3800-4100 K°						2900-3100 K° (2600-2800 K°*)					
CRI (kleurweergave-index)	≥ 80			≥ 80			≥ 80			≥ 90		
Lichtstroom	260 lm			235 lm			388 lm			359 lm		
Afstand	1 m	2 m	3 m	1 m	2 m	3 m	1 m	2 m	3 m	1 m	2 m	3 m
Diameter	0,74 m	1,49 m	2,23 m	0,74 m	1,49 m	2,23 m	0,79 m	1,58 m	2,37 m	0,79 m	1,58 m	2,37 m
Verlichtingssterkte	273,6 lux	68,4 lux	30,4 lux	252,8 lux	63,2 lux	28,1 lux	413,9 lux	103,5 lux	46 lux	383,2 lux	95,8 lux	42,6 lux
Straal	45°			45°			45°			45°		

*Op aanvraag beschikbaar

LED SPOTS

VERSTELBAAR 112 Vierkant

VANESSA 7W - IP40



Afmetingen- mm (inch)

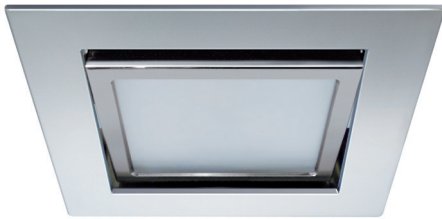

VANESSA 7W - IP40
Veerbevestiging
 Zijrand 112 mm
 Nis 64,5 mm
 Gatgrootte 90x95 mm



VANESSA 6W - IP40

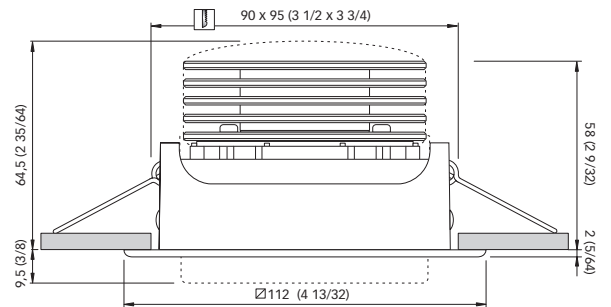

VANESSA 12W - IP40



VANESSA 12W - IP40
Veerbevestiging
Springinstallatie
 Zijrand 112 mm
 Nis 73,4 mm
 Gatgrootte 90x95 mm



12W + Gekleurde sfeerverlichting

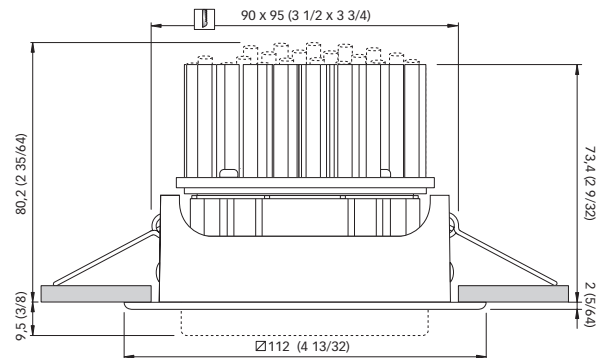

VANESSA 7W / 12W

Installatie
 Dimbaar

Materialen

Roestvrij staal AISI 316

Afwerking

Gepolijst

Satijn

Wit Ral 9010 Andere afwerkingen beschikbaar

op aanvraag.

Modellen	VANESSA 7 WATT			VANESSA 12 WATT		
Lichtbron	LED			LED		
Stroomvoorziening	10 - 30 Vdc			10 - 30 Vdc		
Stroomverbruik	7 W			12 W		
Absorptie	0,58 A @ 12 V / 0,29 A @ 24 V			1A @ 12V / 0,5A @ 24V		
LED-bescherming	Beschermd tegen spanningspieken ± 500 V - Tegen omkering van polariteit					
Polariteit gevoelig	Ja					

Kleurtemperatuur	Daglicht			Warm wit			Daglicht			Warm wit		
	3800-4100 K°			2900-3100 K°			3800-4100 K°			2900-3100 K°		
CRI (kleurweergave-index)	≥ 80			≥ 80			≥ 80			≥ 90		
Lichtstroom	324 lm			311 lm			1019 lm			777 lm		
Afstand	1 m	2 m	3 m	1 m	2 m	3 m	1 m	2 m	3 m	1 m	2 m	3 m
Diameter	1,84 m	3,68 m	5,51 m	1,84 m	3,68 m	5,51 m	2,06 m	4,11 m	6,17 m	2,06 m	4,11 m	6,17 m
Verlichtingssterkte	154,8 lux	38,7 lux	17,2 lux	148,8 lux	37,2 lux	16,5 lux	445,4 lux	111,4 lux	49,5 lux	345,6 lux	86,4 lux	38,4 lux
Straal	85°			85°			90°			90°		

LED SPOTS

112 Vierkant

KRISTINE 7W - IP40



KRISTINE 7W - IP40
Veerbevestiging
 Zijrand 112 mm
 Nis 57 mm
 Gatgrootte 90X90 mm



KRISTINE 6W - IP40

Afmetingen - mm (inch)

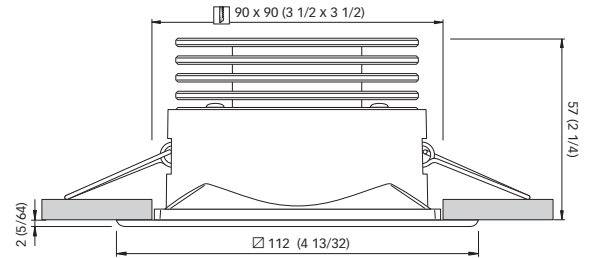

KRISTINE 12W - IP40



KRISTINE 12W - IP40
Veerbevestiging Springinstallatie
 Zijrand 112 mm
 Nis 70,1 mm
 Gatgrootte 90X90 mm



12W + Gekleurde sfeerverlichting

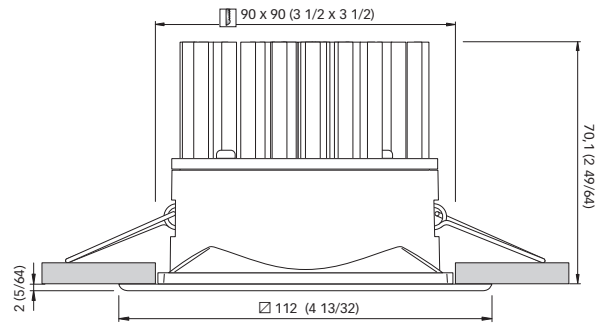

KRISTINE 7W / 12W
Installatie
 Dimbaar

Materialen
 Roestvrij staal AISI 316

Afwerking
 Gepolijst
 Satijn
 Wit Ral 9010
 Andere afwerkingen beschikbaar op aanvraag.

Modellen	KRISTINE 7 WATT			KRISTINE 12 WATT		
Lichtbron	LED			LED		
Stroomvoorziening	10 - 30 Vdc			10 - 30 Vdc		
Stroomverbruik	7 W			12 W		
Absorptie	0,58 A @ 12 V / 0,29 A @ 24 V			1A @ 12V / 0,5A @ 24V		
LED-bescherming	Beschermd tegen spanningspieken ± 500 V - Tegen omkering van polariteit					
Polariteit gevoelig	Ja					

Kleurtemperatuur	Daglicht			Warm wit			Daglicht			Warm wit		
	3800-4100 K°			2900-3100 K°			3800-4100 K°			2900-3100 K°		
CRI (kleurweergave-index)	≥ 80			≥ 80			≥ 80			≥ 90		
Lichtstroom	324 lm			311 lm			1019 lm			777 lm		
Afstand	1 m	2 m	3 m	1 m	2 m	3 m	1 m	2 m	3 m	1 m	2 m	3 m
Diameter	1,84 m	3,68 m	5,51 m	1,84 m	3,68 m	5,51 m	2,06 m	4,11 m	6,17 m	2,06 m	4,11 m	6,17 m
Verlichtingssterkte	154,8 lux	38,7 lux	17,2 lux	148,8 lux	37,2 lux	16,5 lux	445,4 lux	111,4 lux	49,5 lux	345,6 lux	86,4 lux	38,4 lux
Straal	85°			85°			90°			90°		

LED SPOTS

112 Vierkant

Afmetingen- mm (inch)

DEMETRA 7W - IP65



DEMETRA 7W - IP65 Schroefbevestiging

Zijrand 112 mm
Nis 54 mm
Gatgrootte 85x85 mm



DEMETRA 6W - IP65

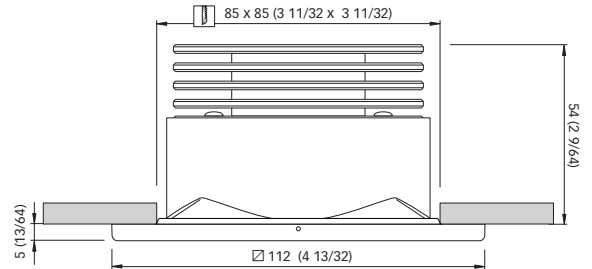

DEMETRA 12W - IP65



Warm wit



DEMETRA 12W - IP65 Schroefbevestiging

Zijrand 112 mm
Nis 70,1 mm
Gatgrootte 85x85 mm



12W + Gekleurde sfeerverlichting

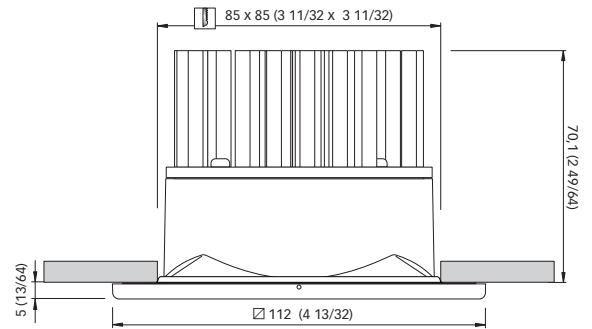

DEMETRA 7W / 12W

Installatie

Dimbaar

Materialen

Roestvrij staal AISI 316

Afwerking

Gepolijst

Satijn

Wit Ral 9010 Andere afwerkingen beschikbaar

op aanvraag.



Modellen	DEMETRA 7 WATT			DEMETRA 12 WATT		
Lichtbron	LED			LED		
Stroomvoorziening	10 - 30 Vdc			10 - 30 Vdc		
Stroomverbruik	7 W			12 W		
Absorptie	0,58 A @ 12 V / 0,29 A @ 24 V			1 A @ 12 V / 0,5 A @ 24 V		
LED-bescherming	Beschermd tegen spanningspieken ± 500 V - Tegen omkering van polariteit					
Polariteit gevoelig	Ja					

Kleurtemperatuur	Daglicht			Warm wit			Daglicht			Warm wit		
	3800-4100 K°			2900-3100 K°			3800-4100 K°			2900-3100 K°		
CRI (kleurweergave-index)	≥ 80			≥ 80			≥ 80			≥ 90		
Lichtstroom	324 lm			311 lm			1019 lm			777 lm		
Afstand	1 m	2 m	3 m	1 m	2 m	3 m	1 m	2 m	3 m	1 m	2 m	3 m
Diameter	1,84 m	3,68 m	5,51 m	1,84 m	3,68 m	5,51 m	2,06 m	4,11 m	6,17 m	2,06 m	4,11 m	6,17 m
Verlichtingssterkte	154,8 lux	38,7 lux	17,2 lux	148,8 lux	37,2 lux	16,5 lux	445,4 lux	111,4 lux	49,5 lux	345,6 lux	86,4 lux	38,4 lux
Straal	85°			85°			90°			90°		

LED SPOTS

Spots glas serie

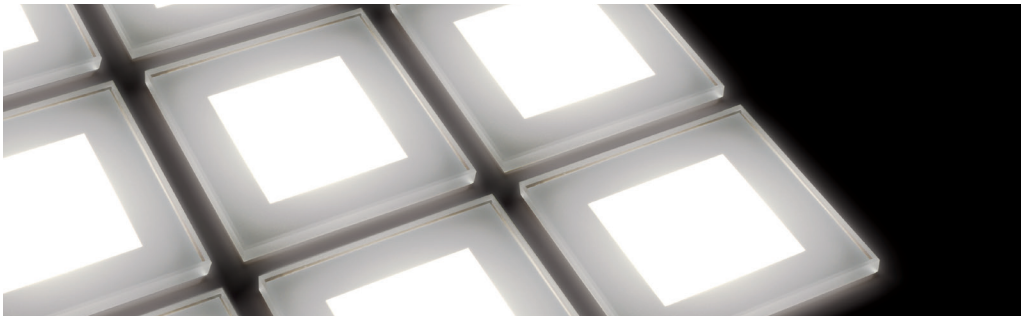

DAPHNE LP/HP 4W

4W Model- IP65- Veerbevestiging Dimbaar

Lichte kleur

Daglicht

Warm wit

DANAE LP/HP - 7W/12W

7W/12W Model- IP40- Veerbevestiging

Dimbaar

Lichte kleur

Daglicht

Warm wit

SUGAR PLATE 18W

18W Model- IP40- Schroefbevestiging

Dimbaar

Lichte kleur

Daglicht

Warm wit

Glas model serie

- DAPHNE LP 4W
- DAPHNE HP 4W
- DANAE LP 7W
- DANAE HP 7W
- DANAE LP 12W
- DANAE HP 12W
- SUGAR LP 3W (pag.121)
- SUGAR HP 3W (pag.121)
- SUGAR PLATE 18W

DAPHNE LP - 4W



DAPHNE LP - 4W - IP65 Veerbevestiging

Dikte 5,5 mm
Schuine kant 86X86 mm
Nis 27 mm
Gatgrootte 60X66 mm



Afmetingen- mm (inch)

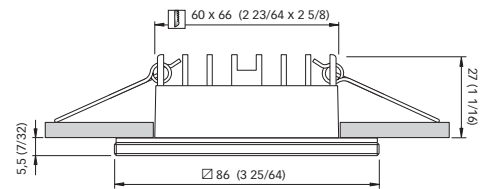

DAPHNE HP - 4W



DAPHNE HP - 4W - IP65 Veerbevestiging

Dikte 9,5 mm
Schuine kant 86X86 mm
Nis 27 mm
Gatgrootte 60X66 mm

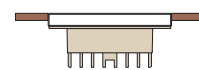
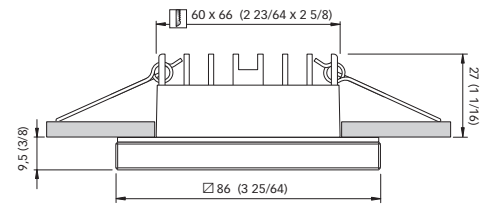

Kan op de vloer worden geïnstalleerd

Installatie

Plafond
Muur
Grond (alleen bij Daphne HP)

Materialen

Glass, Aluminium, ABS

Afwerking

Gehard glas

Modellen

Modellen	DAPHNE LP/HP - 4 WATT					
Lichtbron	LED					
Stroomvoorziening	10 - 30 Vdc					
Stroomverbruik	4 W					
Absorptie	0,33 A @ 12 V / 0,17 A @ 24 V					
LED-bescherming	Beschermd tegen spanningspieken ± 500 V - Tegen omkering van polariteit					
Polariteit gevoelig	Ja					

Kleurtemperatuur	Daglicht			Warm wit		
	3800-4100 K°			2900-3100 K° (2600-2800 K°*)		
CRI (kleurweergave-index)	≥ 80			≥ 80		
Lichtstroom	108 lm			103 lm		
Afstand	1 m	2 m	3 m	1 m	2 m	3 m
Diameter	2,48 m	4,96 m	7,44 m	2,48 m	4,96 m	7,44 m
Verlichtingssterkte	42,3 lux	10,6 lux	4,7 lux	40,3 lux	10,1 lux	4,5 lux
Straal	100°			100°		



LP Versie
Dikte
5,5 mm



HP Versie
Dikte
9,5 mm

LED SPOTS

Spots glas serie

Afmetingen- mm (inch)

DANAE LP - 7W



IP40



DANAE LP - 7W - IP40 Veerbevestiging

Dikte 5,5 mm
Schuine kant 111X111 mm
Nis 57,5 mm
Gatgrootte 90X90 mm

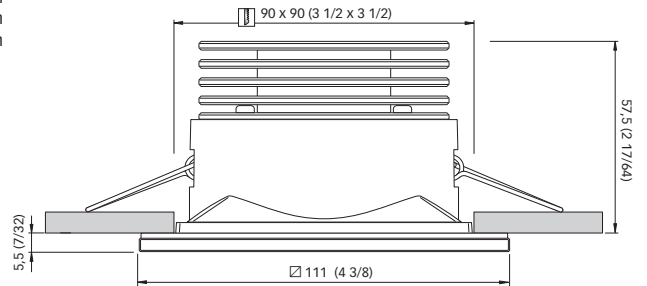

DANAE HP - 7W



IP40



DANAE HP - 7W - IP40 Veerbevestiging

Dikte 9,5 mm
Schuine kant 111X111 mm
Nis 57,5 mm
Gatgrootte 90X90 mm

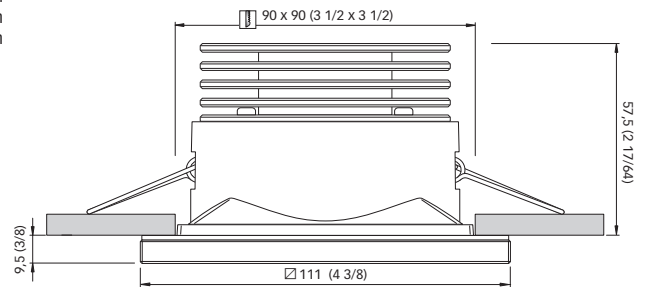

Installatie

Dimbaar

Materialen

Glass, Aluminium, ABS

Afwerking

Gehard glas

Lichtbron

Stroomvoorziening

Stroomverbruik

Absorptie

LED-bescherming

Polariteit gevoelig

LED

10 - 30 Vdc

7 W

0,58 A @ 12 V / 0,29 A @ 24 V

Beschermd tegen spanningspieken ± 500 V
Tegen omkering van polariteit

Ja



LP Versie
Dikte
5,5 mm



HP Versie
Dikte
9,5 mm

Kleurtemperatuur	Daglicht			Warm wit		
	3800-4100 K°			2900-3100 K°		
CRI (kleurweergave-index)	≥ 80			≥ 80		
Lichtstroom	274 lm			264 lm		
Afstand	1 m	2 m	3 m	1 m	2 m	3 m
Diameter	1,81 m	3,63 m	5,44 m	1,81 m	3,63 m	5,44 m
Verlichtingssterkte	130,7 lux	32,7 lux	14,5 lux	125,7 lux	31,4 lux	14,0 lux
Straal	85°			85°		

LED SPOTS

Spots glas serie

DANAE LP - 12W



IP40



CRI 90 Warm wit

Afmetingen- mm (inch)



DANAE LP - 12W - IP40 Veerbevestiging

Dikte 5,5 mm
Schuine kant 111X111 mm
Nis 86,5 mm
Gatgrootte 90X90 mm

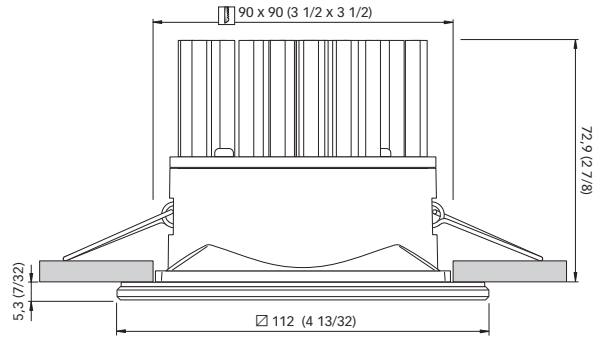

DANAE HP - 12W



IP40



CRI 90 Warm wit



DANAE HP - 12W - IP40 Veerbevestiging

Dikte 9,5 mm
Schuine kant 111X111 mm
Nis 72,9 mm
Gatgrootte 90X90 mm

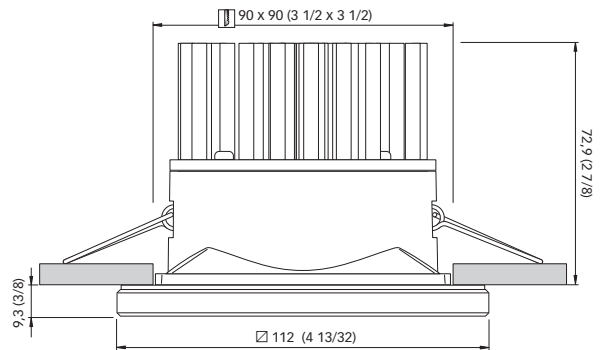

Installatie

Dimbaar

Materialen

Glass, Aluminium, ABS

Afwerking

Gehard glas

Lichtbron

Stroomvoorziening

Stroomverbruik

Absorptie

LED-bescherming

Polariteit gevoelig

LED

10 - 30 Vdc

12 W

1 A @ 12 V / 0,5 A @ 24 V

Beschermd tegen spanningspieken ± 500 V
Tegen omkering van polariteit

Ja

Kleurtemperatuur	Daglicht			Warm wit		
	3800-4100 K°			2900-3100 K°		
CRI (kleurweergave-index)	≥ 80			≥ 90		
Lichtstroom	796 lm			610 lm		
Afstand	1 m	2 m	3 m	1 m	2 m	3 m
Diameter	1,86 m	3,72 m	5,58 m	1,84 m	3,67 m	5,51 m
Verlichtingssterkte	372,5 lux	93,1 lux	41,4 lux	287,9 lux	72,0 lux	32,0 lux
Straal	85°			85°		



LP Versie
Dikte
5,5 mm



HP Versie
Dikte
9,5 mm

LED SPOTS

GLAS SERIE

Afmetingen- mm (inch)

SUGAR PLATE



IP40



SUGAR PLATE 18W - IP40

Schroefbevestiging

Schuine kant 720X150 mm
 Dikte 6 mm
 Nis 32 mm
 Gatgrootte 545X90 mm

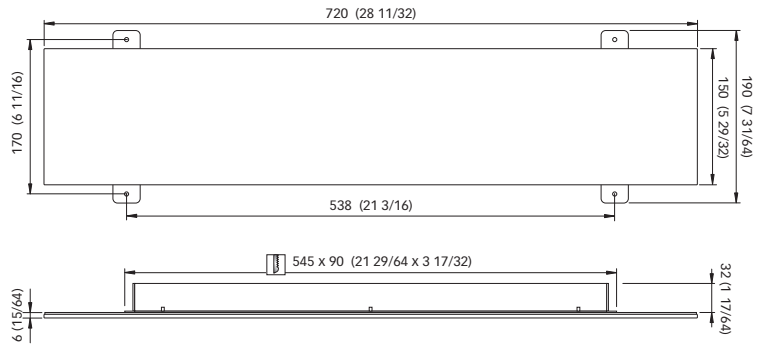

SUGAR PLATE 18W - IP40

Veerbevestiging

Schuine kant 720X150 mm
 Dikte 6 mm
 Nis 32 mm
 Gatgrootte 545X90 mm

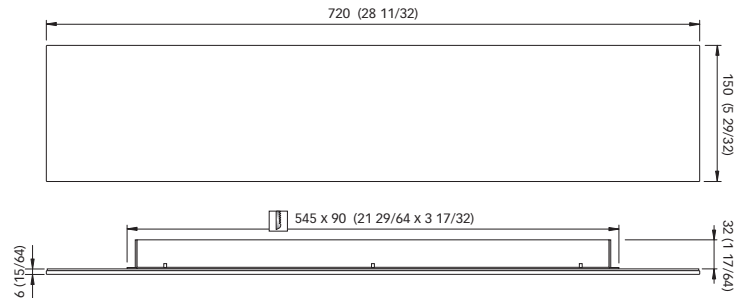

Installatie

Plafond
 Muur

Dimbaar

Materialen
 Glas, aluminium

Afwerking

Gehard glas

Lichtbron

Stroomvoorziening

Stroomverbruik

Absorptie

LED-bescherming

Polariteit gevoelig

LED

10 - 30 Vdc

18 W

0,75 A @ 24 V

Beschermd tegen spanningspieken ± 500 V

Ja



	Daglicht	Warm wit
Kleurtemperatuur	3800-4100 K°	2900-3100 K°
CRI (kleurweergave-index)	≥ 80	≥ 80
Lichtstroom	767 lm	703 lm

LED SPOTS

Ronde modellen

CHIARA 4W - IP66



CHIARA 4W - IP66
Schroefbevestiging
Ø Kroonlijst 88 mm
Nis 28 mm
Ø Uitsparing 65 mm

● ●
4W + Geleerde sfeerverlichting
● ● ● ●

Afmetingen- mm (inch)

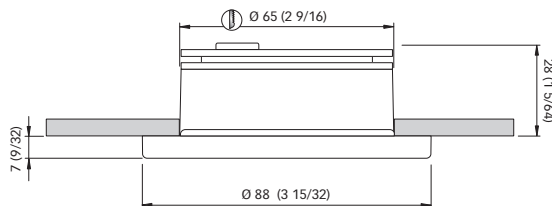

CHIARA 6W - IP66



CHIARA 6W - IP66
Schroefbevestiging
Ø Kroonlijst 88 mm
Nis 41 mm
Ø Uitsparing 65 mm

● ●
6W + Geleerde sfeerverlichting
● ● ● ●
● ● ● ● CHIARA - 6W - IP66 ● ●

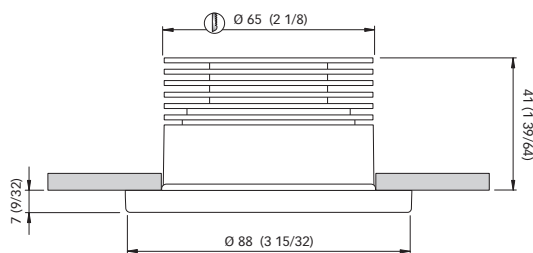

Installatie
Plafond
Dimbaar

Materialen
Roestvrij staal AISI 316
Afwerking
Gepolijst
Satijn
Wit Ral 9010Andere afwerkingen beschikbaar op aanvraag.



CHIARA 6W - IP66

Modellen	CHIARA 4 WATT	CHIARA 6 WATT
Lichtbron	LED	LED
Stroomvoorziening	10 - 30 Vdc	10 - 30 Vdc
Stroomverbruik	4 W	6 W
Absorptie	0,33 A @ 12 V / 0,17 A @ 24 V	0,5 A @ 12 V / 0,25 A @ 24 V
LED-bescherming	Beschermd tegen spanningspieken ± 500 V Tegen omkering van polariteit	
Polariteit gevoelig	Ja	

	Daglicht			Warm wit			Daglicht			Warm wit		
	3800-4100 K°			2900-3100 K° (2600-2800 K°*)			3800-4100 K°			2900-3100 K° (2600-2800 K°*)		
CRI (kleurweergave-index)	≥ 80			≥ 80			≥ 80			≥ 80		
Lichtstroom	266 lm			252 lm			375 lm			280 lm		
Afstand	1 m	2 m	3 m	1 m	2 m	3 m	1 m	2 m	3 m	1 m	2 m	3 m
Diameter	0,73 m	1,45 m	2,18 m	0,73 m	1,45 m	2,18 m	0,73 m	1,46 m	2,20 m	0,73 m	1,46 m	2,20 m
Verlichtingssterkte	266,2 lux	66,5 lux	29,6 lux	241,8 lux	60,5 lux	26,9 lux	370,8 lux	92,7 lux	41,2 lux	269,7 lux	67,4 lux	30,0 lux
Straal	40°			40°			40°			40°		

LED SPOTS

Ronde modellen

Afmetingen - mm (inch)

SONIA 4W - IP66



SONIA 4W - IP66
Schroefbevestiging
 Ø Kroonlijst 105 mm
 Nis 34 mm
 Ø Uitsparing 79 mm

○ ●
4W + Gekleurde sfeerverlichting

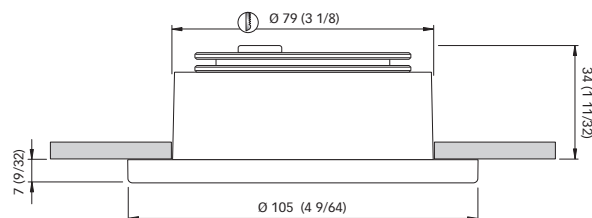

SONIA 9W - IP66



SONIA 9W - IP66
Schroefbevestiging
 Ø Kroonlijst 105 mm
 Nis 57,5 mm
 Ø Uitsparing 79 mm

○ ●
9W + Gekleurde sfeerverlichting

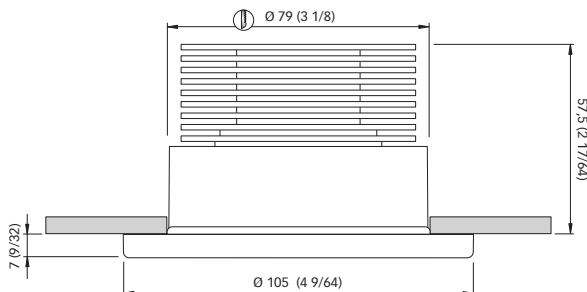

SONIA 9W - IP66

Installatie

Dimbaar

Materialen

Roestvrij staal AISI 316

Afwerking

Gepolijst

Satijn

Wit Ral 9010 Andere afwerkingen beschikbaar

op aanvraag.



Modellen	SONIA 4 WATT	SONIA 9 WATT
Lichtbron	LED	LED
Stroomvoorziening	10 - 30 Vdc	10 - 30 Vdc
Stroomverbruik	4 W	9 W
Absorptie	0,33 A @ 12 V / 0,17 A @ 24 V	0,75 A @ 12 V / 0,38 A @ 24 V
LED-bescherming	Beschermd tegen spanningspieken ± 500 V - Tegen omkering van polariteit	
Polariteit gevoelig	Ja	

Kleurtemperatuur	Daglicht			Warm wit			Daglicht			Warm wit		
	3800-4100 K°			2900-3100 K° (2600-2800 K°*)			3800-4100 K°			2900-3100 K° (2600-2800 K°*)		
CRI (kleurweergave-index)	≥ 80			≥ 80			≥ 80			≥ 80		
Lichtstroom	266 lm			252 lm			395 lm			365 lm		
Afstand	1 m	2 m	3 m	1 m	2 m	3 m	1 m	2 m	3 m	1 m	2 m	3 m
Diameter	0,73 m	1,45 m	2,18 m	0,73 m	1,45 m	2,18 m	0,85 m	1,71 m	2,56 m	0,85 m	1,71 m	2,56 m
Verlichtingssterkte	266,2 lux	66,5 lux	29,6 lux	241,8 lux	60,5 lux	26,9 lux	375,4 lux	93,9 lux	41,1 lux	347,6 lux	86,9 lux	38,6 lux
Straal	40°			40°			50°			50°		

LED SPOTS

Ronde modellen

CRISTIAN 7W - IP40



IP40



CRISTIAN 7W - IP40 Veerbevestiging

Ø Kroonlijst 102 mm
Nis 55 mm
Ø Uitsparing 89 mm



CRISTIAN 6W - IP40

Afmetingen - mm (inch)

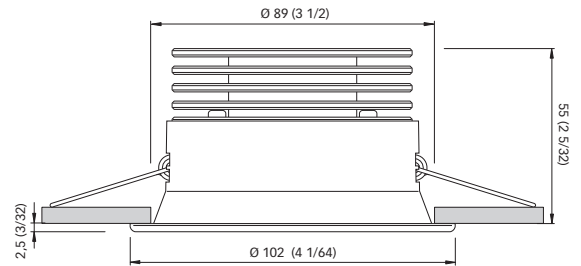

CRISTIAN 12W - IP40



IP40



CRI 90 Warm wit



CRISTIAN 12W - IP40 Veerbevestiging Springinstallatie

Ø Kroonlijst 102 mm
Nis 70,5 mm
Gatgrootte 89 mm



12W + Gekleurde sfeerverlichting

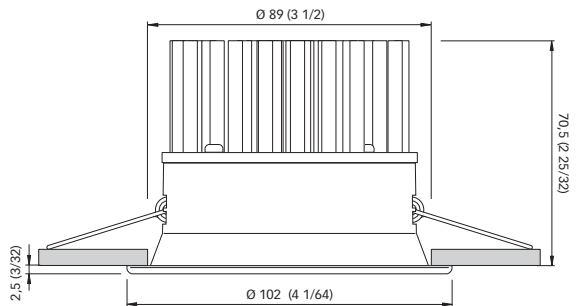

CRISTIAN 7W / 12W

Installatie
Dimbaar

Materialen
Roestvrij staal AISI 316

Afwerking
Gepolijst
Satijn
Wit Ral 9010
Andere afwerkingen beschikbaar op aanvraag.

Modellen	CRISTIAN 7 WATT			CRISTIAN 12 WATT		
Lichtbron	LED			LED		
Stroomvoorziening	10 - 30 Vdc			10 - 30 Vdc		
Stroomverbruik	7 W			12 W		
Absorptie	0,6 A @ 12 V / 0,3 A @ 24 V			1A @ 12V / 0,5A @ 24V		
LED-bescherming	Beschermd tegen spanningspieken ± 500 V - Tegen omkering van polariteit					
Polariteit gevoelig	Ja					

Kleurtemperatuur	Daglicht			Warm wit			Daglicht			Warm wit		
	3800-4100 K°			2900-3100 K°			3800-4100 K°			2900-3100 K°		
CRI (kleurweergave-index)	≥ 80			≥ 80			≥ 80			≥ 90		
Lichtstroom	394 lm			367 lm			1057 lm			794 lm		
Afstand	1 m	2 m	3 m	1 m	2 m	3 m	1 m	2 m	3 m	1 m	2 m	3 m
Diameter	2,04 m	4,09 m	6,13 m	2,04 m	4,09 m	6,13 m	1,90 m	3,80 m	5,70 m	1,79 m	3,58 m	5,37 m
Verlichtingssterkte	169,6 lux	42,4 lux	18,8 lux	159,8 lux	39,9 lux	17,8 lux	498,4 lux	124,6 lux	55,4 lux	388,5 lux	97,1 lux	43,2 lux
Straal	90°			90°			85°			85°		

LED SPOTS

Ronde modellen

THEKLA 9W - IP65



IP65



THEKLA 9W

Schroefbevestiging

Ø Kroonlijst 155 mm

Nis 25 mm

Ø Uitsparing 114 mm



Installatie

Plafond

Dimbaar

Materialen

Roestvrij staal AISI 316

Afwerking

Gepolijst

Satijn

Wit Ral 9010 Andere afwerkingen beschikbaar op aanvraag.

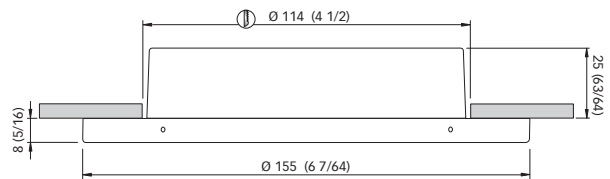

Afmetingen- mm (inch)

Lichtbron

Stroomvoorziening

Stroomverbruik

Absorptie

LED-bescherming

Polariteit gevoelig

LED

10 - 30 Vdc

9 W

0,75 A @ 12 V / 0,38 A @ 24 V

Beschermd tegen spanningspieken ± 500 V

Tegen omkering van polariteit

Ja

Kleurtemperatuur	Daglicht			Warm wit		
	3800-4100 K°			2900-3100 K°		
CRI (kleurweergave-index)	≥ 80			≥ 80		
Lichtstroom	480 lm			454 lm		
Afstand	1 m	2 m	3 m	1 m	2 m	3 m
Diameter	0,77 m	1,54 m	2,31 m	0,77 m	1,54 m	2,31 m
Verlichtingssterkte	622,7 lux	155,7 lux	69,2 lux	593,0 lux	148,3 lux	65,9 lux
Straal	40°			40°		

LED SPOTS

AC series



AISI 316 Roestvrij staal

Gepolijst
Satijn
Wit Ral 9010



Samengesteld

Wit

AC 15W

Model 15W
IP66
Dimbare DALI of 1-10V standaard

Lichte kleur
Daglicht
Warm wit

AC Modellen

KOLE AC IP66
MATHILDA AC IP66
BYRON AC IP66

Plafond

Materialen

Roestvrij staal AISI 316

Afwerking

Gepolijst
Satijn

Andere afwerkingen beschikbaar op aanvraag.

AC PL 15W

Model 15W
IP66
Dimbare DALI of 1-10V standaard

Lichte kleur
Daglicht
Warm wit

AC PL Modellen

KOLE AC PL IP66
MATHILDA AC PL IP66
BYRON AC PL IP66

Plafond

Materialen

Samengesteld materiaal

Afwerking

Wit

Andere afwerkingen beschikbaar op aanvraag.

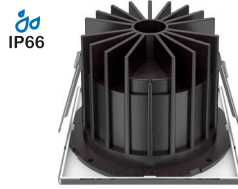

Lichtbron

Stroomvoorziening

Absorptie

Stroomverbruik

LED

110 Vac / 220 Vac

0,07 A @ 220Vac

15 W



Kleurtemperatuur	Daglicht			Warm wit		
		3800-4100 K°			2900-3100 K°	
CRI (kleurweergave-index)	≥ 90			≥ 90		
Lichtstroom	1353 lm			1290 lm		
Efficiëntia / Luminous efficacy	90,2 lm/W			86 lm/W		
Afstand	1 m	2 m	3 m	1 m	2 m	3 m
Diameter	0,7 m	1,4 m	2,1 m	0,68 m	1,37 m	2,05 m
Verlichtingssterkte	1705,7 lux	426,4 lux	189,5 lux	1624,5 lux	406,1 lux	180,5 lux
Straal	40°			40°		

LED SPOTS

AC series

KOLE AC - 15W - IP66



KOLE AC - 15W - IP66
VeerbevestigingSchroefbevestiging

Ø Kroonlijst 126 mm
 Nis 80 mm
 Ø Uitsparing 100 mm

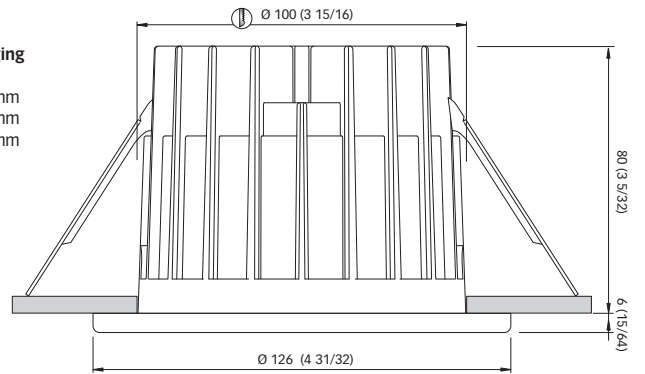

MATHILDA AC - 15W - IP66



MATHILDA AC - 15W - IP66
VeerbevestigingSchroefbevestiging

Zijrand 119 mm
 Nis 80 mm
 Ø Uitsparing 100 mm

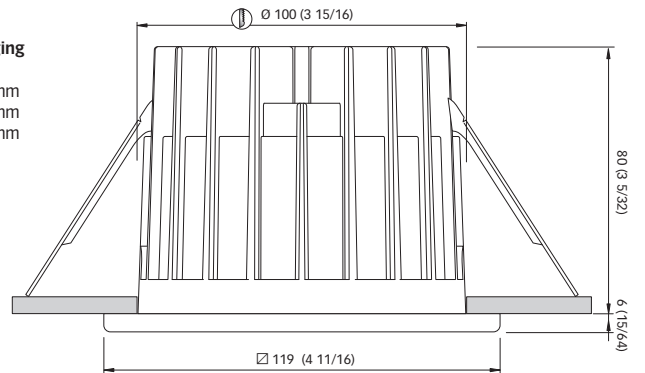

BYRON AC - 15W - IP66



BYRON AC - 15W - IP66
VeerbevestigingSchroefbevestiging

Zijrand 119 mm
 Nis 80 mm
 Ø Uitsparing 100 mm

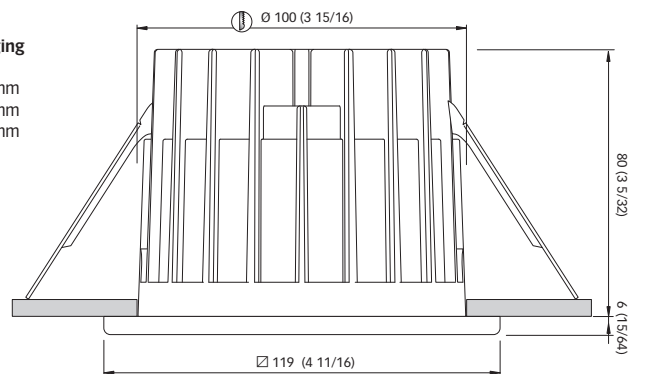

Led inbouwspots

LED SPOTS

AC series

KOLE AC PL - 15W - IP66



KOLE AC PL - 15W - IP66
Veerbevestiging Schroefbevestiging

Ø Kroonlijst 124 mm
 Nis 80 mm
 Ø Uitsparing 100 mm

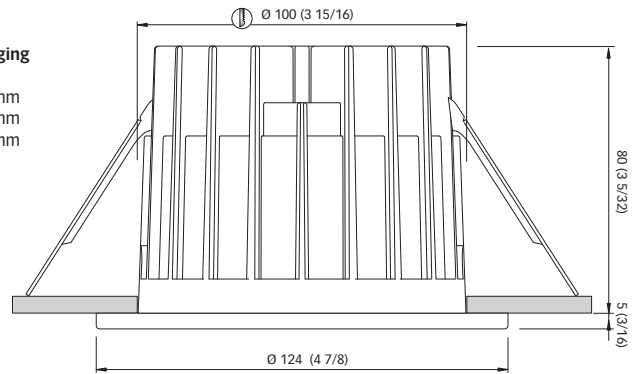

MATHILDA AC PL - 15W - IP66



MATHILDA AC PL - 15W - IP66
Veerbevestiging Schroefbevestiging

Zijrand 117 mm
 Nis 80 mm
 Ø Uitsparing 100 mm

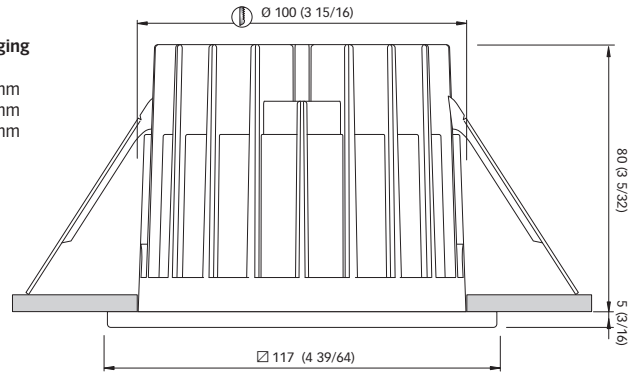

BYRON AC PL - 15W - IP66



BYRON AC PL - 15W - IP66
Veerbevestiging Schroefbevestiging

Zijrand 117 mm
 Nis 80 mm
 Ø Uitsparing 100 mm

